

Dualit®

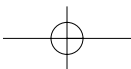

INSTRUCTION AND
GUARANTEE OF
THE SOUP KETTLE

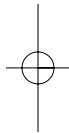
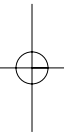
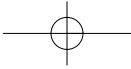

THE DUALIT SOUP KETTLE

INTRODUCTION

Dualit soup kettle are constructed from an aluminium water holder and stainless steel inner liner, with longlife heating elements that reach the desired temperature quickly.

Lids are hinged and removable plus soup kettles come with a set of magnetic display cards.

Perfect for front of house serving of soups, also ideal for foods such as gravy or chilli.

CONTENTS

IMPORTANT SAFEGUARDS.....	4
KNOWING YOUR SOUP KETTLE.....	5
USING YOUR SOUP KETTLE.....	6
SERVICING & GUARANTEE.....	7

IMPORTANT SAFEGUARDS

READ ALL INSTRUCTIONS

- To protect against risk of electrical shock, do not immerse soup kettle in water or other liquid
- Make sure the electrical outlet is rated at the same voltage as that stated on the bottom of the power base
- Unplug from outlet when not in use, before putting on or taking off parts, and before cleaning
- Do not operate the soup kettle with a damaged cord or plug or after appliance malfunctions, or is dropped or damaged in any manner. Return appliance to the nearest Authorized Service Centre for examination, repair or electrical or mechanical adjustment
- Do not use outdoors
- Do not operate on a inclined plane

- Do not let cord hang over edge of table or counter
- Always operate with lid in place
- Keep kettle empty when not in use
- **This is a WET HEAT ONLY kettle, a small amount of water is required between the inner and outer liner in order to operate. Do not overfill**
- The food item must be heated prior to using the soup kettle, the kettle is designed to keep food warm, not for cooking
- Do not operate kettle empty
- Parts and surfaces of the soup kettle will get hot
- Do not operate kettle empty
- This appliance must be earthed
- Never move or carry the kettle when unit is switched on, or containing food
- This appliance is not intended for use by persons (including children) with reduced physical, sensory or mental capabilities, or lack of experience and knowledge, unless they have been given supervision or instruction concerning use of the appliance by a person responsible for their safety
- If the supply cord is damaged, it must be replaced by the manufacturer, its service agent or similarly qualified persons in order to avoid a hazard
- Leave a 40mm clearance round the soup kettle
- The kettle must not be cleaned with a high pressure jet

SAVE THESE INSTRUCTIONS

KNOWING YOUR SOUP KETTLE

PARTS AND CONTROLS

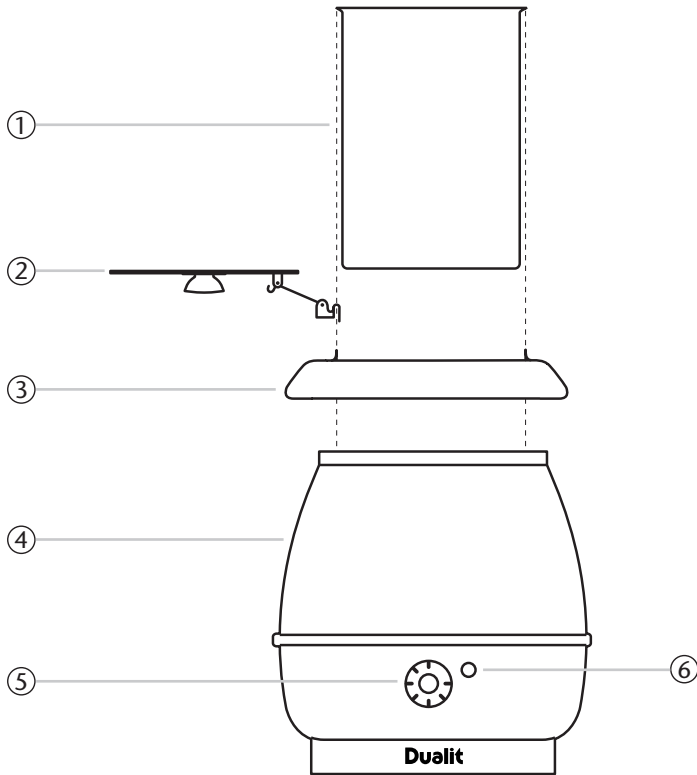

1. Stainless steel liner

2. Lid with hinge

3. Collar

4. Main body

5. Temperature control

'0' = Off position

'1 - 7' = Serving

'8 - 12' = Extra hot

6. Neon indicator

USING YOUR SOUP KETTLE

ASSEMBLING

- Position main body on a clean and level surface
- Place collar on top on main body
- Hold the hinge on the lip of the collar, as shown on diagram page 5
- Insert the stainless steel liner into the main body
- Once assembled the liner will hold the collar and lid in place

OPERATING THE SOUP KETTLE

- Plug unit into correct electrical socket
- This appliance is suitable for **WET HEAT OPERATION ONLY**
Add a maximum of 750ml water between the stainless steel liner and internal aluminium container in the main body. Refill if water level reaches the 'MIN' mark
Never overfill with water and under no circumstances should the stainless steel liner float up, even when empty. Remove any excess water immediately
- Add your already heated food items into the stainless steel liner
- Do not fill above the 'MAX' mark located on the inside of the stainless steel liner
- To turn on, rotate the temperature knob clockwise off the '0' setting
- The neon indicator will glow when the unit is turned on
- Always operate the soup kettle at the lowest possible temperature in order to minimise electricity costs
- Rotate the temperature knob to the desired setting:
1 to 7 - Use during serving periods
8 to 12 - Extra hot setting
- Attach the soup of the day label, insert the name card into the magnetic holder. Fix holder anywhere on the exterior of the main body
- To switch off, turn the dial to '0'.
Unplug from the wall socket to isolate kettle from the electrical supply
- Always keep the removable hinged lid attached and in the closed position when not serving
- Never move or carry the kettle when unit is switched on, or containing food

SERVICING

CLEANING

- Switch off, unplug and un-assemble before cleaning
- Do not let the main body, flex or plug get wet
- Wipe main body with damp cloth, then dry
- Spilled food should be removed immediately from all exterior surfaces
- The stainless steel bain marie and lid are machine washable
- The kettle must not be cleaned with a high pressure jet

GUARANTEE

If your soup kettle fails **within one year from date of purchase** we will repair or replace it free of charge provided:

- You have not misused, neglected or damaged it
- It has not been modified
- You supply your receipt showing When you bought your soup kettle

The guarantee does not affect your statutory rights.

If over one year, contact Dualit for recommended repair agents.

Further advice on using your Dualit soup kettle and other products in the Dualit Range is available from:

Dualit Customer Help line on
+44 (0) 1293 652 500
(09:00 to 17:00 Monday to Friday)

Alternatively email: info@dualit.com

Dualit does not assume any responsibility for incidental or consequential damages.

YOUR NOTES

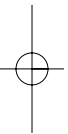
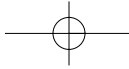

Dualit®  

DUALIT LIMITED COUNTY OAK WAY CRAWLEY WEST SUSSEX RH11 7ST
TELEPHONE: +44 (0) 1293 652 500 FACSIMILE: +44 (0) 1293 652 555
EMAIL: info@dualit.com WEB: www.dualit.com

GB0907

