

Instruction manual

Chamber machine C250

MC06



Serial number:

.....

Service address:

Manufacturer:

MULTIVAC
Sepp Haggenmüller GmbH & Co. KG
Bahnhofstraße 4
D-87787 Wolfertschwenden, Germany
Tel.: 0049 8334 601 0

www.multivac.com

Date: 10.06.2014

The reproduction, distribution and utilization of this document as well as the communication of its contents to others without express authorization is prohibited. Offenders will be held liable for the payment of damages. All rights reserved in the event of the grant of a patent, utility model or design.

Contents

Important information on the manual	6
Machine documentation	6
Changes not covered in the manual	7
Symbols used	7
1 Safety.....	9
1.1 General safety instructions.....	9
1.1.1 Target group.....	9
1.1.2 Unauthorised modifications and manufacture of spare parts.....	11
1.2 EC Conformity.....	12
1.3 Intended use	13
1.3.1 Electromagnetic compatibility (EMC)	13
1.3.2 Non-ionising radiation	13
1.4 Reasonably foreseeable incorrect use.....	13
1.5 Warning against incorrect use.....	14
1.6 Residual risks.....	14
1.7 Obligations of the operating company.....	14
1.7.1 Creating the operating directive	14
1.7.2 Monitoring obligation.....	15
1.7.3 Making the selection of personnel.....	15
1.7.4 Training the personnel	15
1.7.5 Providing personal protective equipment.....	16
1.7.6 Avoiding hazards.....	16
1.7.7 Providing the installation location.....	16
1.7.8 Provide power supply.....	16
1.7.9 Observe the requirements for the gas supply	17
1.7.10 Avoiding hygiene risks	18
1.7.11 Checking the packs.....	18
1.7.12 Pump protection function	19
1.7.13 Testing pressure equipment.....	20
1.8 Safety devices.....	20
1.8.1 Safety devices.....	21
1.9 Machine labels	21
1.9.1 Safety labels and information labels	22
2 Description.....	25
2.1 Design of the machine	25
2.1.1 Front view.....	25
2.1.2 Rear view	26
2.2 Control terminal.....	27
2.3 Display	28
2.3.1 Startup display	28
2.3.2 Status display.....	29
2.3.3 Function display	30
2.3.4 Diagnostic display	31

2.3.5	Access rights.....	31
2.4	Menu tree.....	32
2.5	Process sequence.....	32
2.6	Packaging process.....	33
2.7	Preset recipes.....	33
2.8	Technical data.....	34
3	Start-up.....	38
3.1	Initial start-up.....	38
3.1.1	Setting up the machine.....	38
3.1.2	Adding oil to the vacuum pump.....	38
3.2	Connecting the power supply.....	39
3.3	Connecting inert gas.....	39
3.4	Cleaning the machine (basic cleaning).....	40
4	Operation.....	41
4.1	Switching on the machine.....	41
4.2	Switching off the machine.....	41
4.3	Packing products.....	42
4.4	Opening and closing menus.....	45
4.4.1	Calling up menus.....	45
4.4.2	Quitting menus.....	45
4.5	Changing values.....	45
4.6	Selecting and resetting access rights.....	46
4.6.1	Selecting access authorisations.....	46
4.6.2	Resetting the access right to operator (blocking access).....	46
4.6.3	Change password for authorisation access creator.....	46
4.6.4	To reset authorisation access creator.....	47
4.7	Language selection.....	47
4.7.1	Selecting the language via menu.....	47
4.7.2	Selecting the language via the shortcut key.....	47
4.8	Working with recipes.....	47
4.8.1	Load recipe.....	47
4.8.2	Load factory settings.....	48
4.8.3	Save recipe.....	48
4.8.4	Delete recipe.....	49
4.9	Select and set process.....	49
4.9.1	Set standard process.....	49
4.9.2	To set MCV process.....	49
4.10	Setting the sealing.....	50
4.11	Entering basic settings.....	50
4.12	Modifying and resetting machine cycles.....	50
4.13	Display production data.....	51
4.13.1	Display total cycles of the machine.....	51
4.13.2	Display hours of operation.....	51
4.13.3	Display cycle time.....	51
4.13.4	Show settings.....	51

4.14	Setting the brightness of the display	52
5	Adjustment work and setup	53
5.1	Insert and remove the sloping insert	53
6	Cleaning	54
6.1	Notes on cleaning	54
6.1.1	Rules of conduct	54
6.1.2	Creating a company cleaning directive	54
6.1.3	Measures for ensuring a long service life.....	54
6.1.4	Parameters for pre-rinsing and after-rinsing water.....	55
6.1.5	Handling cleansers.....	55
6.1.6	Use with disinfectant	56
6.1.7	Corrosion protection and lubrication	57
6.1.8	Cleaning devices.....	57
6.2	Cleaning the machine	58
6.2.1	Performing daily cleaning.....	58
6.2.2	Performing intensive cleaning	63
6.3	Care products table.....	65
7	Maintenance.....	67
7.1	Maintenance schedule	67
7.2	Maintenance recommendation.....	68
7.2.1	Entire machine - Perform a wipe test.....	68
7.2.2	Vacuum pump - Perform the pump protection function.....	68
7.2.3	Entire machine - Visual inspection	68
7.2.4	Entire machine - Alkaline cleaning and disinfection	69
7.2.5	Vacuum pump - Checking oil level, topping up	69
7.2.6	Entire machine - Acidic cleaning and disinfection	69
7.2.7	Connections - Visual inspection	69
7.2.8	Vacuum system - Check	69
7.2.9	Vacuum pump - Oil change.....	69
7.2.10	Vacuum pump - Exchanging the air de-oiling element.....	69
7.2.11	Entire machine - Check the age.....	70
7.3	Performing the vacuum test	70
7.4	Replace the sealing bar	70
7.4.1	Remove the sealing bar	70
7.4.2	Install the sealing bar	71
7.5	Change the oil in the vacuum pump.....	72
7.5.1	Drain oil.....	72
7.5.2	Adding oil to the vacuum pump.....	73

8	Troubleshooting	75
8.1	Malfunctions with diagnostic message	75
8.2	Faults without diagnostic message	76
9	Shutdown, transport, storage	79
9.1	Taking the machine out of service	79
9.2	Transporting the machine	79
9.2.1	Transporting the machine	79
9.3	Storing the machine	80
10	Disposal	81
10.1	Disposing of the machine	81
10.2	Dispose of operating materials	81
10.2.1	Disposing of oil and grease	81
10.2.2	Disposing of packaging materials	82
10.2.3	Dispose of chemicals	82
11	Spare parts	84
	Glossary	86
	Index	89
	MULTIVAC branch offices	92

Important information on the manual

Read the manual carefully before you begin working with the machine.

- This manual is an integral component of the unit. Keep the manual for future reference.
- Do not work with the machine until you have read through the manual and completely understood its contents.
- Please contact MULTIVAC as soon as possible if there is something you do not understand in the manual! Your comments will help us to further improve the manual.
- Do not start up the machine if there are any visible defects!
- Only trained persons are permitted to install, operate and service the machine. The operating company is responsible for the qualifications and training of operating personnel.
- If you sell, transfer ownership or lend the machine to others, you must provide the manual along with it!

For reasons of clarity, some illustrations show the machine without the prescribed safety devices. Operating the machine without the safety devices is prohibited.



Injury hazard!

Altered, damaged, defective or incorrectly applied or missing safety devices will render the danger zones unprotected.

Unprotected danger zones can cause serious or even fatal injuries.

- Do NOT alter the safety devices.
- Use only MULTIVAC spare parts and accessories.

Before switching on the machine each time:

- Check that all safety guards close completely and prevent reaching into the danger zones.
- Check that only those safety devices are used which are suitable for the machine equipment.
- Check that all safety devices are functional and in a technically flawless condition.

Machine documentation

- Instruction manual.
- EU Declaration of Conformity
- Supplementary sheet "Super-PIN" (loose page enclosed with the machine).



Info

The complete scope of delivery is listed in the order confirmation.

Changes not covered in the manual

Continuous development is the foundation for ensuring that our machines are technically advanced and of high quality. For this reason, you may discover slight deviations between the specifications in the manual and your machine. We also cannot rule out errors. The specifications, figures and descriptions in this manual do not constitute a legal contract between the manufacturer and customer.

Symbols used

Warnings draw your attention to hazards. Warnings are displayed in the following form:



Danger from electrical shock!

Used to indicate that serious danger of electrical shock is imminent. Ignoring this danger can cause serious or even fatal injuries.

- Observe the notices for avoiding danger.



Immediate danger!

Used to indicate that serious danger is imminent. Ignoring this danger can cause serious or even fatal injuries.

- Observe the notices for avoiding danger.



Dangerous situations!

Used to indicate dangerous situations. Non-observance can cause serious or even fatal injuries.

- Observe the notices for avoiding danger.



Potentially dangerous situations!

Used to indicate potentially dangerous situations. Ignoring this danger can cause injuries.

- Observe the notices for avoiding danger.

NOTICE

Danger of material damage!

Used to indicate potentially dangerous situations. Ignoring these situations can cause material damage.

- Observe the notices for avoiding danger.

Information that contributes to a better understanding of how the machine functions is shown in the following form:



Info

Indicates information on special features deserving your attention.

Instructions to follow are displayed in the following form:

➤ Press key A.

➤ Release screw B.

➤ Press key C.

- Enumerated items are marked with bullet points.
 - Dashes are used to mark sub-items of enumerated lists or sequences of steps to be taken.

1 Safety

1.1 General safety instructions

The machine incorporates the latest technological principles. Nevertheless, potential hazards for persons, the machine and other materials cannot be entirely excluded.

- Before you start up the machine, read through the instruction manual and follow the instructions contained therein.
- Keep the instruction manual near the machine for future reference.
- Observe the safety and accident prevention regulations valid in your country.

1.1.1 Target group

The persons, who work with or at the machine, must have as a minimum requirement the following capabilities, knowledge and competence:

- The persons are authorized by the company operating the machine to carry out those tasks, which they perform with or at the machine.
- The persons are at least 14 years old.
- The persons know the danger zones of the machine and the accident prevention regulations.
- The persons know how they should behave in an emergency situation.
- The persons have been given instruction about the machine and are familiar with the handling of it.
- The persons have read and understood the operating directive.
- The persons have read and understood the instruction manual of the machine.
- The persons have been informed about the possible hygiene risks.

The persons, who put the machine into service, or adjust and set it up, or who are responsible for maintenance work and eliminating faults, must have the following capabilities, knowledge and competence:

- Due to their professional training, knowledge and experience, as well as their familiarity with the relevant regulations, the persons are able to assess the tasks assigned to them and to recognize potential hazards.
- The persons can read and interpret technical texts and technical drawings or plans.
- The persons are familiar with the handling of computer-controlled machines.
- The persons can install components and modules for technically complex systems.

- The persons can ensure that the machine remains capable of operation.
- The persons can perform maintenance work and inspections.

The persons, who carry out work on electrical components, must have as a minimum requirement the following capabilities, knowledge and competence:

- Due to their professional training, knowledge and experience, as well as their familiarity with the relevant regulations, the persons are able to assess the tasks assigned to them and to recognize potential hazards.
- The persons have been trained as qualified electricians and are able to prove this.
- The persons have up-to-date knowledge and experience in the electrical area, and they have actively practised these skills in recent years.

The persons, who carry out work on gas supplies, must have as a minimum requirement the following capabilities, knowledge and competence:

- Due to their professional training, knowledge and experience, as well as their familiarity with the relevant regulations, the persons are able to assess the tasks assigned to them and to recognize potential hazards.
- The persons have been trained in handling gas supplies and are able to prove this.
- The persons have up-to-date knowledge and experience in gas supplies, and they have actively practised these skills in recent years.



Injury hazard!

Operating the machine in a negligent and inattentive manner is very dangerous.

Negligent handling, inattentiveness and a disorderly work area can cause serious injuries.

- Do NOT operate the machine if you are tired or under the influence of alcohol or medication.
 - Work attentively and with care.
 - Wear personal protective equipment.
 - Keep the work area clean and orderly.
 - Only carry out work for which training has been given.
-

NOTICE **Danger of material damage!**

Improper use of the machine can damage it. Damage can cause faults in the machine, which in turn can result in reject packs.

- Do NOT overload the machine.
- Clean and service the machine on a regular basis.
- Check if the machine is in full working order prior to starting work.
- Do NOT start the machine if you notice defects, damage or a change in the operating behaviour of the machine.
- Have faults and damage repaired immediately by an authorised technician.
- Repairs and service work should only be carried out by an authorised technician.

1.1.2 Unauthorised modifications and manufacture of spare parts

Genuine MULTIVAC spare parts and accessories provide the highest level of safety for personnel. Parts and equipment from other manufacturers have not been tested by MULTIVAC and are therefore not approved. The use of such components can alter the properties of the machine and thereby impair safe operation.



Injury hazard!

It is very dangerous to use third-party parts. The use of third-party parts endangers safe operation and can cause serious injuries.

- Do NOT perform any unauthorised modifications or conversions.
- Do NOT modify or remove any protective or safety devices.
- Use only MULTIVAC spare parts and accessories.

The manufacturer disclaims any liability for damage caused by the use of third-party parts or unauthorised modifications.



**Choose the Original
Choose Success!**

Fig. 1: Pro Original

The lubricants recommended by MULTIVAC are ideally matched to the individual modules of the machine.

NOTICE Danger of material damage!

The use of unsuitable lubricants can increase the wear of the machine and lead to corrosion of the transport chains.
This can damage the machine.

- Only use recommended lubricants for the transport chains.
-

1.2 EC Conformity

In the design and construction of packaging lines, packaging machines or auxiliary equipment for packaging machines, the following regulations have been observed:

- EC Machinery Directive 2006/42/EC.
- EC Electromagnetic Compatibility Directive 2004/108/EEC (exception: industrial trucks such as lifting trolleys and die changing trolleys).
- Regulation 1935/2004/EC on materials and articles intended to come into contact with food.

The safety objectives of the EC Low Voltage Directive 2006/95/EC are complied with in accordance with point 1.5.1 of Annex I to the EC Machinery Directive 2006/42/EC (exception: industrial trucks such as lifting trolleys and die changing trolleys).

Agent authorised to compile the relevant technical documentation according to Directive 2006/42/EC:

MULTIVAC Sepp Hagenmüller GmbH & Co. KG
Department of Technical Services
Bahnhofstraße 4
87787 Wolfertschwenden, Germany

Manufacturer:

MULTIVAC Sepp Hagenmüller GmbH & Co. KG
Bahnhofstraße 4
87787 Wolfertschwenden, Germany

Managing Director:

H.-J. Boekstegers

Agent authorised to compile the relevant technical documentation according to Directive 2006/42/EC:

MULTIVAC Packaging Systems España, S.L.
Avda. Sot de les Vernedes, 22-26
E-08396 Sant Cebrià de Vallalta

Manufacturer:

MULTIVAC Packaging Systems España, S.L.
Avda. Sot de les Vernedes, 22-26
E-08396 Sant Cebrià de Vallalta

Plant Manager:

Txus Baquero

1.3 Intended use

The machine is a piece of technical equipment to be used exclusively as a working appliance. The machine may only be operated by persons older than 14 years of age.

Use the machine only to pack products in pre-made film pouches.

The film pouches are closed with a seal seam.

For specifications, see Technical specifications.

Any other use is considered improper and can endanger persons, the product and the machine.

1.3.1 Electromagnetic compatibility (EMC)

The machine has been designed for use in residential, business and industrial areas (without a separate power substation, it can be connected directly to the public mains). Operation can be impaired when used in an industrial environment.

1.3.2 Non-ionising radiation

The machine produces unintended non-ionising radiation. This is only emitted by electrical operating equipment as a function of its inherent technical nature. e.g. from electric motors, high voltage wires, magnetic coils. There are moreover no strong permanent magnets built into the machine. Any effect on active implants can therefore be excluded with a high degree of probability as long as a safety distance of 30 cm is maintained between the implant and the field source. Active implants can be: heart pacemakers, defibrillators etc.

1.4 Reasonably foreseeable incorrect use

The following work methods are not in accordance with regulations and therefore are prohibited:

- Operation in an atmosphere capable of explosion.
- Packing of highly flammable, combustible or explosion-prone products.
- Packing of dust-forming or powder-forming material.
- Gas flushing of film pouches with explosive gas mixtures (e.g. oxygen proportion over 21 %).

- Use of the chamber lid and the viewing window in the chamber lid as a storage, working or cutting surface.
- Cleaning of the chamber lid and the viewing window in the chamber lid with cleaning agents which have an abrasive effect (e.g. abrasive household liquid cleaner, scouring pads, steel wool etc).
- Aseptic packing of products.

**Info**

Misuse will exclude any liability on behalf of the manufacturer. In such a case, the operating company alone bears the risk.

1.5 Warning against incorrect use

- Incorrect operation
For example: sealing times that are too short or too long and therefore result in improperly sealed packs which in turn damage the product.
- Neglecting the following work tasks:
 - Inspections.
 - Cleaning work.
 - Maintenance work.
- Use of third-party parts, i.e. parts that are not MULTIVAC spare parts.
- Operation under prohibited ambient conditions.

1.6 Residual risks

The safety instructions in this manual serve as guidelines for trained operating personnel in safe working practice with the machine. The manufacturer cannot however foresee all possible product-related hazards. This is why the safety instructions and warnings on the machine and in this manual cannot be considered exhaustive. The operating company and operating personnel remain ultimately responsible for safety.

1.7 Obligations of the operating company

1.7.1 Creating the operating directive

The machine and operating materials are a potential source of hazards. The operating company is obliged to draw up an operating directive. The operating directive regulates the handling of hazardous machines or operating materials, as well as laying down rules for behaviour in the case of an emergency. The required information can be found in the following documents:

- The EC directives for worker protection.
- National legislation.
- Accident prevention regulations.

- The machine instruction manual.

1.7.2 Monitoring obligation

The operating company is obliged to continuously monitor the condition of the entire machine, for example:

- Visible defects or damage.
- Changes in the operating behaviour.
- Age of the machine.

The operating company is obliged to ensure, that the machine is no longer operated when it is older than 19 years. The correct functioning of the safety functions for the electronic components can no longer be guaranteed after this age. The year of manufacture on the type plate of the machine serves as the starting point for assessing the age. In order to be able to operate the machine after this, the operating company must commission the manufacturer to check the safety functions of the machine.



Info

Do NOT start up the machine, if there are visible defects or if the machine is older than 19 years.

1.7.3 Making the selection of personnel

The operating company has to choose the personnel according to the tasks to be carried out, see Section 1.1.1 "TARGET GROUP". The operating company has to order and authorise the personnel for the tasks to be carried out.



Info

Trainees or other persons receiving instructions may only operate the unit under the constant supervision of an experienced technician.

1.7.4 Training the personnel

The operating company is responsible for ensuring, that the personnel is trained and instructed in accordance with the tasks, which have been assigned to them. The following measures can for example contribute to the training and instruction:

- Provide an operating directive, which is comprehensible to the personnel.
- Instruct personnel on how to handle the machine correctly.
- Make the machine instruction manual accessible to the personnel. If necessary, order an instruction manual from the manufacturer in the appropriate official language.
- Inform the personnel about measures for avoiding hygiene risks.
- MULTIVAC offers appropriate training courses.

1.7.5 Providing personal protective equipment

The operating company must ensure that the operators wear the required personal protective equipment (foot protection, head gear, gloves, etc.) in accordance with the national directives which apply. In Europe the directive 89/656/EEC specifies the minimum mandatory requirements for the use of personal protective equipment.

1.7.6 Avoiding hazards

The operating company must check, whether there are special hazards during operation, e.g. through hazardous fumes. The operating company must undertake measures to avoid or limit the hazards.

1.7.7 Providing the installation location

The operating company is obliged to provide a suitable installation location for the machine. The requirements for the installation location can be obtained from the manufacturer.

1.7.8 Provide power supply

Connect the machine to the mains electricity at an always easily accessible place. In the case of an emergency the machine must be capable of being disconnected immediately from the mains electricity. The power supply must be equipped as follows:

- Overcurrent protective device according to IEC 60204-1: 2005.
- Mains power breaker according to IEC 60204-1: 2005.

Connection via residual current protective device

If the machine is to be operated via a residual current protective device, a residual current protective device which is sensitive to all types of current should be used.



Info

In exceptional cases, the leakage current can be so high that an isolating transformer needs to be installed between the power supply and the machine.

Connection to IT network

The machine cannot be connected directly to an IT network. The IT network must be converted to a TN-S network by an isolating transformer. The machine is connected to the TN-S network.

1.7.9 Observe the requirements for the gas supply



Info

Compliance with the following requirements is mandatory and is one of the operating company's imperative obligations!

General requirements

- The operating company is obliged to connect the gas supply in a way that poses no danger to employees or third parties.
- The operating company is obliged to create an instruction manual with all safety-related information for the following phases in the service life of the machine:
 - Starting up.
 - Operation and conduct in the event of unusual occurrences.
 - Servicing during operation.
 - Shutdown.
 - Rectification of faults.
- All parts of the gas supply and its equipment, which come into contact with oxidizing acting gases, are to be kept free of oil and grease.
- The operating company must ensure that the input and operating pressures given in the Technical specifications are adhered to and not exceeded.

Personnel qualifications

Only qualified persons with the corresponding required training, experience and reliability may perform work on the gas supply.

Structural requirements

- The operating company is obliged to install a pressure reducer and safety valve in the gas supply line to the machine.
- The operating company is obliged to connect the machine to the gas supply with a lockable ball valve.

When the ball valve is closed, the supply of gas to the machine is interrupted.
- It must be ensured that the input pressure at the machine does not exceed that given in the Technical specifications, e.g. through the fitting of an overpressure valve.
- The pressure relief capacity of the safety valve must be dimensioned for the maximum possible throughput of the pressure reducer.
- In the case of a release of pressure, the gas must be diverted to non-hazardous areas.

1.7.10 Avoiding hygiene risks

A high standard of hygiene is achieved through design, choice of materials and workmanship.

It is imperative that this high level of hygiene be maintained by every operating company. Particularly where food or sterile medical products are being packed, the currently valid hygiene standards must be strictly observed. The person charged by the operating company with safety and/or hygiene must clarify, which regulations apply to the product to be packed, and the person must then implement these regulations.

The manufacturer assumes no liability whatsoever for any warranty claims and damage claims of any kind resulting from insufficient hygiene and insufficient cleaning.



Health hazard!

Insufficient or sporadic cleaning can promote the growth of microorganisms which can change unfavourably the product that is to be packed.

This can severely damage the health of people, especially of the consumers.

Among other measures the following are definitely required:

- Create a company cleaning guideline.
- Perform cleaning regularly.
- Check the effectiveness of cleaning procedures on a regular basis.
- Follow instructions in the chapter 'Cleaning'.

1.7.11 Checking the packs



Health hazard!

Faulty or damaged packs (reject packs) can have far-reaching consequences, for example, spoiled products.

Spoiled products can pose a health hazard.

- Check packs on a regular basis during running operation.
- Do NOT put faulty or damaged packs (reject packs) into circulation.



Info

It is the operating company's duty to determine the overall testing procedure.

Testing procedure

Depending on the film pouch and the demands placed on the packs, various types of testing procedures are available, e.g.:

- Check seal seam width.
- Visual inspection: Asses the pack optically.

- Storage test: Store a good pack for a defined period and then re-inspect.
- Stacking test: Stack good packs on top of each other for a defined period and then re-inspect.
- Check the seal seam strength with a tensile testing machine.
- Low-pressure test (for vacuum packs).
- Measurement residual oxygen (for gas-flushed packs).

The following faults can result in a pack not being airtight:

- A leaky seal seam. Possible reasons:
 - The inside of the packaging material is contaminated by product in the seal seam area.
 - The sealing time is too short.
- Damage to the pack caused e.g. by sharp-edged products.

Time of inspection

- After machine start-up.
- When a defined time interval was reached during running operation.
- When the pack size was changed.
- When other types of films or other film thicknesses are being used.
- When spare parts or wearing parts were built in.
- After faults to the machine were eliminated.
- After changes to the machine settings.

1.7.12 Pump protection function

The vacuum pump in the machine runs for a set time when the chamber lid has been closed. During this time any undesired liquid in the oil of the vacuum pump evaporates. This increases the lifespan of the vacuum pump. When packaging moist or liquid products, the operating company is obliged to perform this function at least once a day at the end of a working day. The manufacturer assumes no liability whatsoever for any warranty claims and damage claims of any kind that result from the insufficient performance of this function.

NOTICE Danger of material damage!

Penetration by foreign matter (e.g. liquids, product residue, foreign bodies) will damage the vacuum pump.

Damage can cause faults in the machine, which in turn can result in reject packs.

- Cancel the evacuation process immediately if foreign matter is sucked in.
 - Change the oil in the vacuum pump.
-

1.7.13 Testing pressure equipment

The operating company is responsible for observing the country-specific test intervals for pressure equipment. This test is to be performed by qualified persons.

1.8 Safety devices

Safety devices on the machine:



Fig. 2: Safety devices

1 Protective device



Injury hazard!

Altered, damaged, defective or incorrectly applied or missing safety devices will render the danger zones unprotected.

Unprotected danger zones can cause serious or even fatal injuries.

- Do NOT alter the safety devices.
- Use only MULTIVAC spare parts and accessories.

Before switching on the machine each time:

- Check that all safety guards close completely and prevent reaching into the danger zones.
- Check that only those safety devices are used which are suitable for the machine equipment.
- Check that all safety devices are functional and in a technically flawless condition.

1.8.1 Safety devices

Safety devices cover the danger zones lying beneath them. Depending on the equipment of the machine, various safety devices are used, e.g. side panels, doors, protective plates, etc.



Injury hazard!

Missing protective devices result in unprotected danger zones. Reaching into unprotected danger zones can lead to serious or even fatal injuries.

- Do NOT put the machine into operation without protective devices.
- Check that all protective devices are attached and in a technically flawless condition.
- Check that all protective devices are completely closed without gaps.

1.9 Machine labels

Safety and information labels have been attached to the machine.

- Do NOT remove these labels.
- Make sure all labels are intact and legible.
- If necessary, clean the labels with soap and water.
 - Do NOT clean the labels with solvents.
- Replace damaged, scratched or illegible labels with new ones.



Info



Labels can be obtained from the manufacturer.





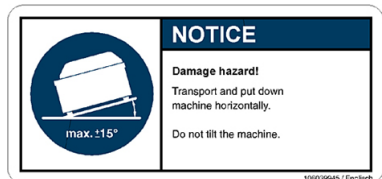

1.9.1 Safety labels and information labels

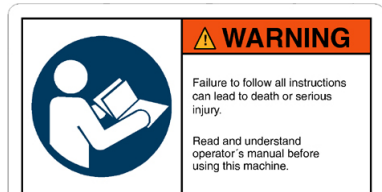
Front view



Fig. 3: Front view of the position of the labels

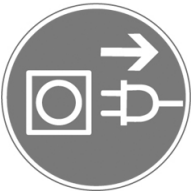
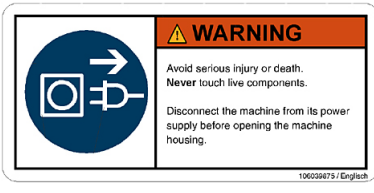

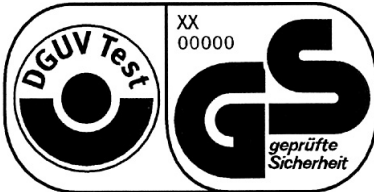
Position	Sign	
1	<div data-bbox="609 1252 802 1442" data-label="Image">  </div> <div data-bbox="606 1449 979 1516" data-label="Caption"> <p>Fig. 4: ISO mandatory sign: inclination of the machine</p> </div>	<div data-bbox="1015 1252 1398 1429" data-label="Image">  </div> <div data-bbox="1008 1442 1410 1507" data-label="Caption"> <p>Fig. 5: ANSI mandatory sign: inclination of the machine</p> </div>
2	<div data-bbox="609 1585 802 1776" data-label="Image">  </div> <div data-bbox="606 1785 1000 1850" data-label="Caption"> <p>Fig. 6: ISO mandatory sign: Read the instruction manual</p> </div>	<div data-bbox="1015 1585 1398 1776" data-label="Image">  </div> <div data-bbox="1008 1798 1391 1863" data-label="Caption"> <p>Fig. 7: ANSI mandatory sign: Read the instruction manual</p> </div>

Position	Sign
	<div style="display: flex; justify-content: space-around;"> <div style="text-align: center;">  <p>Fig. 8: ANSI mandatory sign: Read the instruction manual (English / French)</p> </div> <div style="text-align: center;">  <p>Fig. 9: ANSI mandatory sign: Read the instruction manual (English / Spanish)</p> </div> </div>
	<div style="display: flex; justify-content: space-around;"> <div style="text-align: center;">  <p>Fig. 10: ANSI mandatory sign: Read the instruction manual (English / Japanese)</p> </div> <div style="text-align: center;">  <p>Fig. 11: ANSI mandatory sign: Read the instruction manual (English / Chinese)</p> </div> </div>
3	<div style="display: flex; justify-content: space-around;"> <div style="text-align: center;">  <p>Fig. 12: ISO mandatory sign: unplug the power plug</p> </div> <div style="text-align: center;">  <p>Fig. 13: ANSI mandatory sign: unplug the power plug</p> </div> </div>
4	<div style="text-align: center;">  <p>Fig. 14: Type plate</p> </div>
5	<div style="text-align: center;">  <p>Fig. 15: GS mark</p> </div>

Rear view



Fig. 16: Rear view of the position of the labels

Position	Sign
1	 <p data-bbox="699 1485 1161 1507">Fig. 17: Safety label on gas connection (option)</p>
2	 <p data-bbox="699 1765 1145 1787">Fig. 18: Inert gas input pressure sign (option)</p>

2 Description

2.1 Design of the machine

2.1.1 Front view



Fig. 19: Front view

- 1 Chamber lid
- 2 Counter-pressure bar
- 3 Chamber lid gasket
- 4 Sealing bar with gas nozzle (option)
- 5 Chamber
- 6 Control terminal
- 7 Locking for lid

2.1.2 Rear view



Fig. 20: Rear view

- 1 Power supply connection
- 2 (Optional) Inert gas connection
- 3 Screw plug of fill opening
- 4 Screw plug of drain opening with oil sight glass

2.2 Control terminal

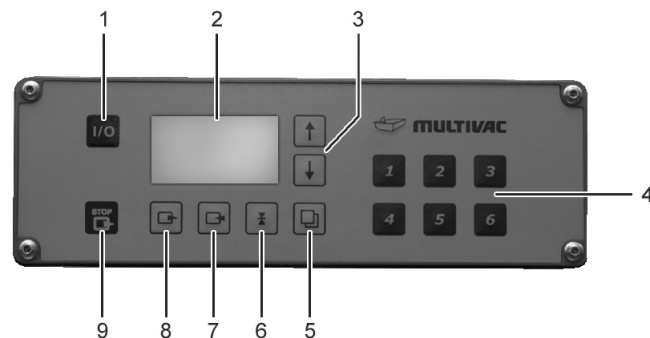











Fig. 21: Control terminal

- 1 <Machine control On/Off> key
- 2 Display
- 3 Keys <Arrow key>
- 4 Keys <1> to <6>
- 5 <Function selection> key
- 6 <Sealing> key
- 7 <Gas flushing> key
- 8 <Evacuation> key
- 9 <Stop> key

	<Machine control On/Off>	<ul style="list-style-type: none"> • Switch machine control on and off.
	Display	<ul style="list-style-type: none"> • Display process data. • Show menus. • Show parameters and functions. • Graphic support. • Display diagnostic messages.
	<Arrow key>	<ul style="list-style-type: none"> • Increase values. • Navigation within menus.
	<Arrow key>	<ul style="list-style-type: none"> • Decrease values. • Navigation within menus.
	Keys <1> to <6>	<ul style="list-style-type: none"> • Load and save recipes. • Enter password. • Enter the configuration code.
	<Function selection>	<ul style="list-style-type: none"> • Call up additional menus. • Scroll to previous screen.

	<Sealing> key	<ul style="list-style-type: none"> • Press and hold down: Call up "Sealing" menu. • Press briefly: Call up values for sealing. • Confirm the configuration code. • In the MPP process: select the value.
	<Gas flushing> key	<ul style="list-style-type: none"> • In the MPP process: select the function. <p>In machines with the inert gas option:</p> <ul style="list-style-type: none"> • Press and hold down: Call up "Gas flushing" menu. • Press briefly: Call up values for gas flushing.
	<Evacuation> key	<ul style="list-style-type: none"> • Press and hold down: Call up "Evacuation" menu. • Press briefly: Call up values for evacuation. • Delete configuration code. • In the MPP process: select the step
	<Stop> key	<ul style="list-style-type: none"> • Skip current machine process and proceed with the next process. <ul style="list-style-type: none"> – Pressing during the evacuation process: Aborts the evacuation process and resumes the gas flushing process. – Pressing during the gas flushing process: Aborts the gas flushing process and resumes the sealing process. – Press during sealing process: Cancel sealing process and ventilate the chamber. • Acknowledge diagnostic message. • Return from the menu to the status display.

2.3 Display

The display shows different views with differing information depending on the machine's phase of operation.

2.3.1 Startup display

The startup screen appears after switching on the machine.

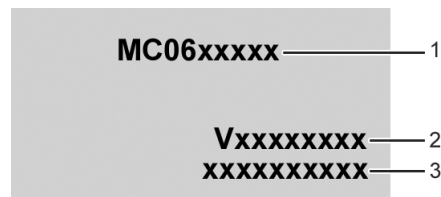

Fig. 22: Startup display

- 1 Type designation of machine control
- 2 Software version
- 3 Configuration code

2.3.2 Status display

Process data status display

The process data status display shows information on the last packaging procedure.

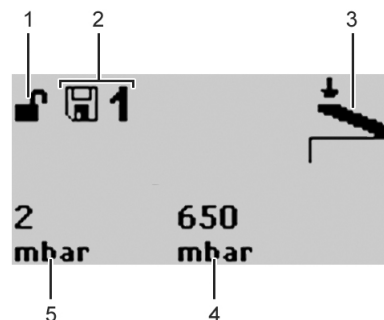

Fig. 23: Process data status display

- 1 Current access right (lock closed = user; lock open = set-up personnel)
- 2 Currently loaded recipe
- 3 Chamber lid symbol, machine is ready.
- 4 Gas pressure
- 5 Evacuation pressure

Process sequence status display

The process sequence status display shows the progress of the currently running process, e.g. evacuation. During the process the corresponding symbol flashes on the display. If time runs out during a process, then a clock with the remaining time will flash in place of the symbol.



Fig. 24: Evacuation status display (047)



Fig. 25: Gas flushing status display (049)



Fig. 26: Sealing status display (050)

2.3.3 Function display

Depending on the access rights, the function display will offer the following options:

- View values.
- Enter values.
- Switch functions on and off.

Example of a function display with values:

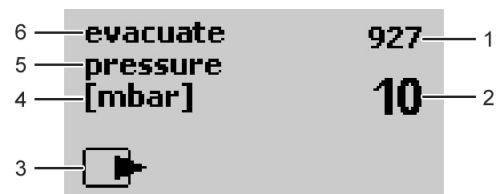

Fig. 27: Function display with value (052)

- 1 Actual value
- 2 Setting
- 3 Symbol of function (e.g. evacuation)
- 4 Measurement
- 5 Selected parameter
- 6 Selected function

Example of a function display for switching a function on and off:

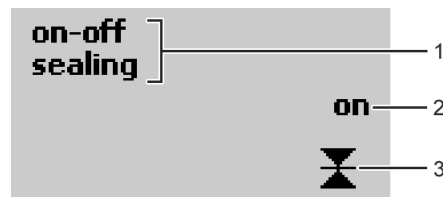

Fig. 28: Function display on/off (013)

- 1 Selected function
- 2 Switch status
- 3 Symbol of function (e.g. sealing)

2.3.4 Diagnostic display



Fig. 29: Diagnostic display

- 1 Diagnostic number
- 2 Type of error acknowledgement
- 3 Error text (in ticker)

Eliminate the malfunction, see Section 8 "TROUBLESHOOTING".

2.3.5 Access rights

To avoid incorrect operation, the following access rights are assigned.

Access right	Explanation
Operator	Not password protected. The operator may enter settings that are required to operate the machine (e.g. Language choice). The operator cannot modify values.
Set-up personnel	Password protected. The set-up personnel can modify values and switch statuses. Only a limited number of settings in the service menu are possible (e.g. vacuum test).
Service	Unrestricted authorisation.
Super-PIN	<ul style="list-style-type: none"> • Reset password for access right <i>Set-up personnel</i> to factory setting. • Reset machine control.

2.4 Menu tree

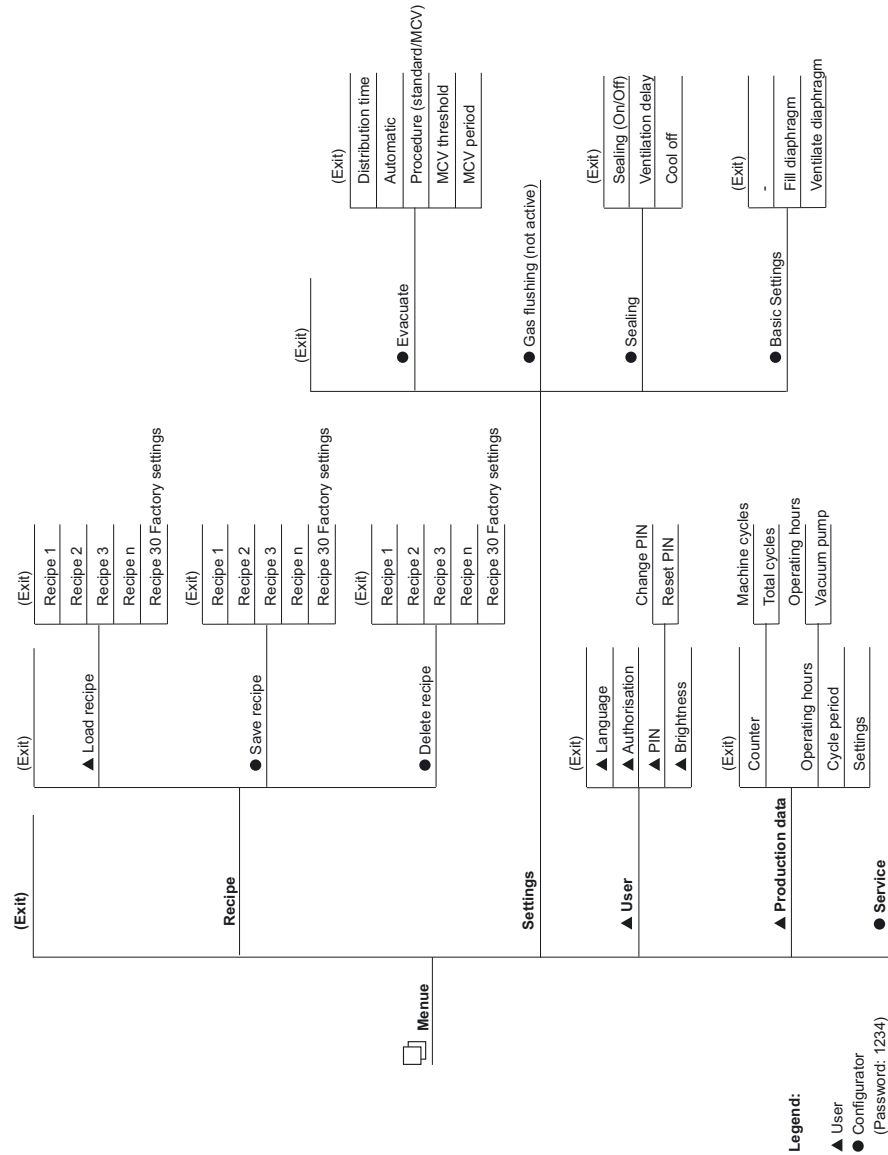

Fig. 30: Menu tree

2.5 Process sequence

The film pouches are filled and laid in the chamber. When the chamber is closed, the following procedures run automatically:

	Evacuation	Evacuation if chamber and film pouches.
	Gas flushing (optional)	Infeed of inert gas.



Sealing

- Compressed air is admitted to the sealing diaphragm. The sealing diaphragm expands, pressing the sealing bar against the counter-pressure bar.
- The film pouch is sealed.
- The sealing bar and seal seam cool off.
- The sealing diaphragm is ventilated, the sealing diaphragm slackens.
- The chamber is ventilated.
- The chamber lid opens automatically if it is not locked.

2.6 Packaging process

The following processes are available for packing products.

Processes	Example of use
Standard	Technical products or products without special requirements.
MCV	Testing airtightness of packs or for drying products.

2.7 Preset recipes

Recipes 1 to 6 are preset at the factory. The settings depend on the machine equipment.



Info

Recipes 1 to 6 contain presettings which have to be adjusted to the individual cases.

Recipe	Example of use	Evacuation pressure	Automatic sensitivity	Gas flushing pressure	Sealing time	MHP
No. 1	For dry products without gas flushing.	Automatic	4	Off	1.8 s	Off
No. 2	For moist products without gas flushing.	Automatic	10	Off	1.8 s	Off

Recipe	Example of use	Evacuation pressure	Automatic sensitivity	Gas flushing pressure	Sealing time	MHP
No. 3	For dry products with little gas flushing.	Automatic	4	100 mbar to 150 mbar	1.8 s	Off
No. 4	For dry products with medium gas flushing.	Automatic	4	250 mbar	1.8 s	Off
No. 5	For dry products with strong gas flushing.	Automatic	4	500 mbar	1.8 s	Off
No. 6	For products with a big air pocket.	12 mbar	10	Off	1.8 s	Evacuation time: 2 s Evacuation pause: 4 s
No. 30	Factory settings	10 mbar	6	Off	1.3 s	Evacuation time: 2 s Evacuation pause: 2 s

2.8 Technical data

Power supply connection

Mains voltage	See type plate.
Phases	See type plate.
Nominal power	See type plate.
Nominal current	See type plate.
Maximum pre-fuse	See type plate.
Max. short-circuit current	See type plate.
Protection type	IP54

Dimensions

Height (a) with open chamber lid	730 mm
----------------------------------	--------

Dimensions

Height (a) with closed chamber lid	460 mm
Width (b)	560 mm
Depth (c)	520 mm
Operating height approx.	346 mm
Effective chamber size (W/H/D)	465 mm/150 mm/290 mm
Sealing length	465 mm
Weight approx.	80 kg



Fig. 31: Dimensions

Installation conditions and ambient conditions

Ambient temperature	+2 °C to +40 °C
Storage temperature	-25 °C to +80 °C
Relative air humidity during operation or storage of the machine, max.	90 % non-condensing
Inclination of the machine during transport, max.	15 °
Minimum room size for machines with the gas flushing option*	40 m ²

Installation conditions and ambient conditions

*For safety reasons, a minimum room size is mandatory to prevent high concentrations of gas.

Inert gas (option)

Max. input pressure	2.5 bar
Min. input pressure	0.7 bar
Inner diameter of supply line	8 mm

Vacuum pump.

Vacuum pump	21 m ³ /h
Achievable final pressure approx.	2 mbar

Noise exposure at workplace

Based on	Machinery Directive (2006/42/EG)
Measuring instrument	Sound level meter, IEC 61672- 1, class 1, fault limit +/-1,1 dB
Condition of the machine	New condition with optimum settings at the time of delivery.
A-weighted emission sound-pressure level at the workplace L _{pA} (DIN ISO 11204, accuracy class 3)	<70 dB

Noise exposure at workplace

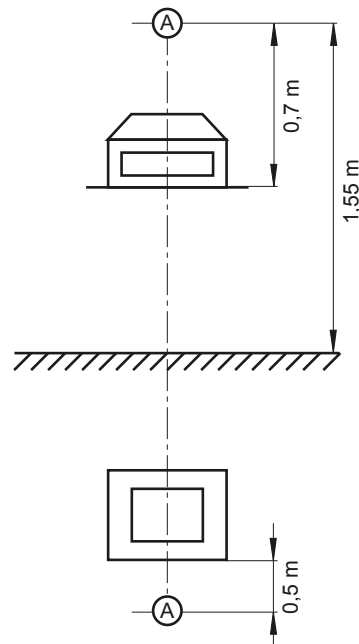

Fig. 32: Noise exposure measuring point



Info

The readings of the noise data have been adjusted to take extraneous and ambient noises into account.

Higher readings may be produced as a result of the following:

- Highly sound-reflecting rooms.
- Modified settings.
- Wear.

3 Start-up

3.1 Initial start-up

3.1.1 Setting up the machine

- Prepare a firm, level site for the machine.
 - Ensure there is adequate access to the connections at the desired location.
 - Observe the technical specifications.
-



Danger of explosion!

Operating the machine in a potentially explosive atmosphere can result in explosion due to hot machine parts. Explosions can cause serious injuries or even death.

- Do NOT use the machine in rooms that are exposed to explosion hazards.
-

NOTICE Danger of material damage!

At an inclination of more than 15°, the oil in the vacuum pump shifts.

The air de-oiling elements will get wet from the oil and become ineffective. This will damage the vacuum pump.

- Transport and set the machine down as horizontally as possible.
 - Do NOT tilt the machine.
-

- Transport the machine to the desired location, see Section 9.2.1 "TRANSPORTING THE MACHINE".
-

- Set up the machine on a firm, level base.
-

3.1.2 Adding oil to the vacuum pump

- Fill oil into the vacuum pump, see Section 7.5.2 "ADDING OIL TO THE VACUUM PUMP".
-

3.2 Connecting the power supply

NOTICE **Danger of material damage!**

If the mains voltage of the machine does not match that of the mains, the machine will be overloaded. This can damage the vacuum pump.

- Connect the machine to the mains electricity only if the voltages are identical.

- Check the mains voltage on the type plate and compare it with the voltage of the mains electricity.

- If the values match, connect the machine to the mains electricity in an always easily accessible place.

3.3 Connecting inert gas



Danger of explosion!

Gas mixtures with oxygen proportions over 21% are explosive. A gas mixture with an oxygen proportion over 21 % can cause an explosion and fire if it comes in contact with heat, oil or grease.

- Do NOT use a gas mixture with an oxygen proportion of over 21%.



Risk of death!

During the packing process, inert gases are released. Inhaling inert gas can impair your breathing. Over a longer period of time, this can be fatal.

- A surface area of at least 40 square meters per machine must be made available.
- Ventilate the rooms sufficiently and avoid any accumulation of gas.
- Observe the maximum input pressure, see 'Technical specifications'.
- Cut off the gas supply at the end of work.
- Adhere to the safety regulations in effect in the country where the machine is used.



Info

Observe the minimum and maximum permitted input pressure, see "Technical specifications".

- Attach a stop-cock to the gas supply on the operating side.
- Attach the gas hose to the inert gas connection of the machine.

-
- Fasten the hose with hose clamps.
 - Open the stop-cock for the gas supply.
 - Set the input pressure; see the section technical specifications.
-

3.4 Cleaning the machine (basic cleaning)

- After putting the machine into service carry out an intensive cleaning of the machine, see Section 6 "CLEANING".
-



Info

The machine is only to be used for production after a basic cleaning.

4 Operation

4.1 Switching on the machine

- Before switching on the machine for the first time fill the vacuum pump with oil, see Section 7 "MAINTENANCE".
 - If present, open the stop-cock for the gas supply.
 - Connect the machine to the mains electricity at a place which is always easily accessible.
 - Press the <Control On/Off> key.
 - The machine control performs a self-test.
 - The software version of the machine control briefly appears in the display.
 - The status display appears.
 - The machine is ready for operation.
-

4.2 Switching off the machine

- Press the <Control On/Off> key.
 - The screen for performing the pump protection function appears.
 - If necessary, perform the pump protection function.
 - Close and press down the chamber lid.
 - The vacuum pump runs for a set time.
 - A counter counts to zero.
 - The display goes out.
 - The chamber lid opens automatically if it is not locked.
 - To cancel the pump protection function, press the <Control On/Off> key again.
 - The display goes out.
-



Info

The display goes out automatically after 10 s without input or without closing the chamber lid.

- Close chamber lid and lock it in place.
 - Close the stop valve for the gas supply, if part of the machine.
 - If required disconnect the machine from the mains electricity.
-

4.3 Packing products

- Switch on the machine.

 - Load the desired recipe.
 - For the first test packs, use a preset recipe, see Section 2.7 "PRESET RECIPES " and see Section 4.8.2 "LOAD FACTORY SETTINGS ".
-



Health hazard!

Insufficient or sporadic cleaning can promote the growth of microorganisms which can contaminate the product.

This can pose serious health hazards for consumers.

- Disinfect your hands should they come into contact with any machine part other than the operating elements.
 - Do NOT lay the product on the machine.
 - Observe the company cleaning guidelines.
 - Follow instructions in the chapter 'Cleaning'.
-

- Fill the film pouch.
-



-
- Insert film pouch.
 - The opening of the film pouch extends 2 to 3 cm beyond the sealing.
-

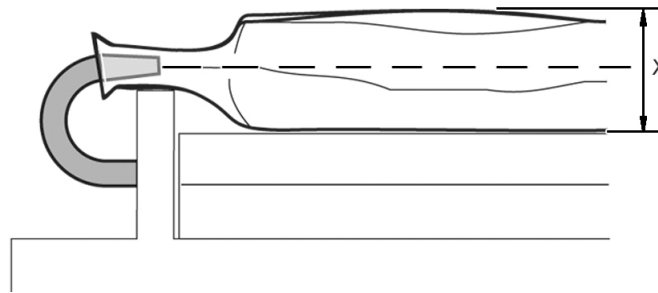

- If necessary, use spacer plates.
 - The pouch neck is centred on the pouch height x .
- Use the diagonal insert for packaging liquids, see Section 5.1 "INSERT AND REMOVE THE SLOPING INSERT".
 - Liquid cannot escape from the film pouch.

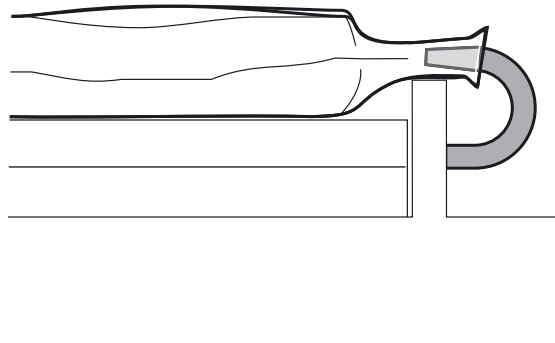

- Gas flushing option: Pull the pouch opening over the gas nozzles so that the inert gas flows into the film pouch.
- Pull the pouch neck flat on the sealing bar.
 - The pouch neck lies on the sealing bar without creases.



NOTICE Danger of material damage!

Penetration by foreign matter (e.g. liquids, product residue, foreign bodies) will damage the vacuum pump.

Damage can cause faults in the machine, which in turn can result in reject packs.

- Cancel the evacuation process immediately if foreign matter is sucked in.
- Change the oil in the vacuum pump.

-
- Close and press down the chamber lid.
 - The processes in the machine run automatically.
 - The chamber lid opens automatically if it is not locked.
-



-
- Remove the finished pack.

-
- Check the pack.
-

**Info**

Visually inspect the packs on a regular basis while the machine is running. Depending on product and pack it may be necessary to carry out additional and considerably more complex test procedures. This is the responsibility of the operator, see Section 1.7.11 "CHECKING THE PACKS".

- If necessary, adapt the settings to the product.
 - Enter all required times and values.
 - Save recipe, see Section 4.8.3 "SAVE RECIPE".
-

4.4 Opening and closing menus

4.4.1 Calling up menus

- Press the <function selection> key.
 - The "main menu" appears.
 - Select the desired menu with the <arrow> keys.
 - Press the <function selection> key.
 - The desired menu appears.
 - Select the desired submenu with the <arrow> keys.
 - Press the <function selection> key.
 - The desired submenu appears.
-

4.4.2 Quitting menus

- Using the <arrow> keys, select the respective menu heading.
 - The text of the menu heading changes and becomes the (menu) function *quit*.
 - Press the <function selection> key.
 - The menu is exited and the system changes to the next highest display level.
-

4.5 Changing values

- Call up the desired menu.
 - Using the <arrow> keys, select the desired parameter.
-

-
- Press the <function selection> key.
 - The display for the selected parameter appears.
 - Set the value with the <arrow> keys.
 - The set value is adopted.
 - To exit the parameter, press the <Function selection> key.
-

4.6 Selecting and resetting access rights

4.6.1 Selecting access authorisations

-
- Call up "User" menu.
 - Select *Authorisation*.
 - Enter the password with the keys <1> to <6>.
 - The corresponding access right appears in the status display.
 - If the selected access authorisation is no longer needed, reset the access to *operator*, see Section 4.6.2 "RESETTING THE ACCESS RIGHT TO OPERATOR (BLOCKING ACCESS)".
-

4.6.2 Resetting the access right to operator (blocking access)

-
- Call up "User" menu.
 - Select *Authorisation*.
 - Enter the password of the current access right with the keys <1> to <6>.
 - The *Operator* access right appears in the status display.
 - Settings cannot be changed.
-

4.6.3 Change password for authorisation access creator

-
- Call up "PIN" menu.
 - Select *Change PIN*.
 - Enter old password with keys <1> to <6>.
 - Enter new password with keys <1> to <6>.
 - Confirm the new password again.
 - The password has been changed.
 - The status display appears.
-

4.6.4 To reset authorisation access creator

- Call up "PIN" menu.
 - Select *Reset PIN*.
 - Enter Super-PIN, see supplementary sheet "Super-PIN".
 - The reset password for the authorisation access *Creator* appears.
 - The status display appears.
-

4.7 Language selection

4.7.1 Selecting the language via menu

- Call up "User" menu.
 - Select *Language*.
 - Using the <arrow> keys, select the desired language.
 - Press the <Function selection> key.
 - The language is activated.
-

4.7.2 Selecting the language via the shortcut key

- Switch off the display with the <Machine control on/off> key.
 - Switch on the display with the <Machine control on/off> key.
 - While the startup display is shown, press the <Function selection> key.
 - The "language selection" display appears.
 - Using the <arrow> keys, select the desired language.
 - Press the <function selection> key.
 - The language is activated.
-

4.8 Working with recipes

4.8.1 Load recipe



Info

If no recipe is saved, the message "recipe missing" appears. The last settings remain active.

Load using keys <1> to <6>

-
- Press the desired key briefly <1> to <6>.
 - The selected recipe is loaded.
-

Loading through the “load recipe” menu

-
- Call up "Load recipe" menu.
 - Select the desired recipe with the <arrow> keys.
 - Press the <Function selection> key.
 - The selected recipe is loaded.
-

4.8.2 Load factory settings



Info

Factory settings cannot be overwritten or deleted.

-
- Call up "Recipe loading" menu.
 - Select recipe no. 30 with the <arrow> keys.
 - Press the <Function selection> key.
 - The factory settings are loaded.
-

4.8.3 Save recipe



Info

When selecting an already assigned recipe number, the recipe stored under this number is directly overwritten.

Saving via keys <1> to <6>

-
- Press and hold down desired key <1> to <6>.
 - The message "Recipe saved" appears.
 - The current values are stored in the selected recipe.
-

Saving via the “save recipe” menu

-
- Call up "Recipe, saving" menu.
 - Using the <arrow> keys, select the desired memory location.
-

-
- Press the <Function selection> key.
 - The current values are stored in the selected recipe.
-

4.8.4 Delete recipe



Info

If the currently loaded recipe is deleted, a new recipe must be loaded.

-
- Call up "Recipe, deleting" menu.
-
- Select the recipe to be deleted with the <arrow> keys.
-
- Press the <Function selection> key.
 - The message "completed" appears.
 - The recipe has been deleted.
-

4.9 Select and set process

4.9.1 Set standard process

-
- Press <Evacuation> key briefly and enter value for *Evacuation pressure*.
 - For automatic evacuation, decrease the value until *Automatic* appears.
 - The machine controls the evacuation process automatically.
-
- Press <Evacuation> key briefly again and set value for *Post-evacuation time*.
-
- Call up the "evacuation" menu.
 - Set *Distribution time*.
 - Set *Automatic*.
 - Select *Standard* process.
-
- Call up the "gas flushing" menu (Optional).
 - Switch on *On/off gas flushing*.
 - Set *Distribution time*.
 - Set *Rinse time*.
-
- Press <Gas flushing> key briefly and set value for *Gas flushing pressure*.
-

4.9.2 To set MCV process

-
- Press <Evacuation> key briefly and enter value for *Evacuation pressure*.
-



Info

Do not set an *Evacuation pressure* value in *Automatic*.

-
- Press <Evacuation> key briefly again and set the value for *Post-evacuation time* to 0 s.
-
- Call up the "evacuation" menu.
 - Set the value for *Distribution time* to 0 s.
 - Select *MCV* process.
 - Set *MCV threshold*.
 - Set *MCV duration*.
-
- Call up the "gas flushing" menu (Optional).
-
- Switch off *Gas flushing On/Off*.
-
- Call up the "sealing" menu.
-
- Switch off *Sealing On/Off*.
-

4.10 Setting the sealing

-
- Call up the "sealing" menu.
 - Switch on *On/off sealing*.
 - Set *Delayed ventilation*.
 - Set *Cooling down*.
-
- Press <Sealing> key briefly and set value for *Sealing time*.
-

4.11 Entering basic settings

-
- Call up the "basic settings" menu.
 - Set *Fill diaphragm*.
 - Set *Ventilate diaphragm*.
-

4.12 Modifying and resetting machine cycles

-
- Call up the "operating data" menu.
-
- Call up "Counter" menu.
-
- Call up *machine cycles*.
-
- Set the value with the <arrow> keys or set to "0".
 - The set value is adopted.
-

4.13 Display production data

4.13.1 Display total cycles of the machine

- Call up the "operating data" menu.

- Call up "Counter" menu.

- Select *Total cycles*.

4.13.2 Display hours of operation

Display machine's hours of operation

-
- Call up the "Operating data" menu.

 - Call up "Hours of operation" menu.

 - Select *Hours of operation*.

Display vacuum pump's hours of operation

-
- Call up the "Operating data" menu.

 - Call up "Hours of operation" menu.

 - Select *Vacuum pump*.

4.13.3 Display cycle time

- Call up the "operating data" menu.

- Select the "Cycle time" menu.
 - A list of cycle times is displayed.

4.13.4 Show settings

- To view the settings of recipes 7 through 30, load the desired recipe via the menu, see Section 4.8.1 "LOAD RECIPE".

- Call up the "production data" menu.

- Select *Settings*.
 - The settings of the loaded recipe appear in a list.



Info

The settings of recipes 1 through 6 can be speed dialed from the list. To do so, load the respective recipe with the keys <1> through <6>.

4.14 Setting the brightness of the display

- Call up "User" menu.

- Select *brightness*.

- Using the <arrow> keys set the desired brightness.

5 Adjustment work and setup

5.1 Insert and remove the sloping insert

- If necessary, use filling plates for the desired incline.
 - Hook the sloping insert on the screws of the sealing bar.
-

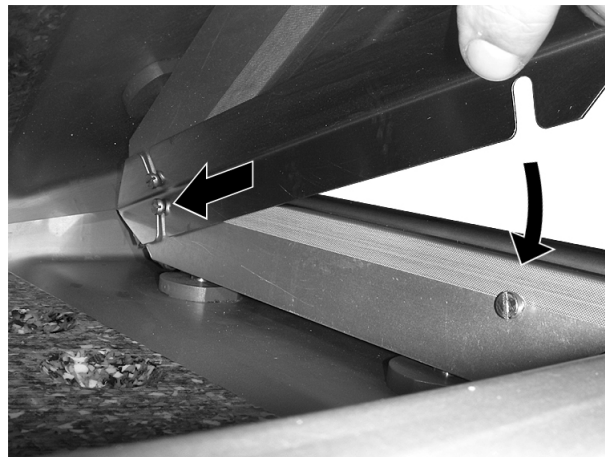

-
- Attach the support angle to the sloping insert at the required position.
-

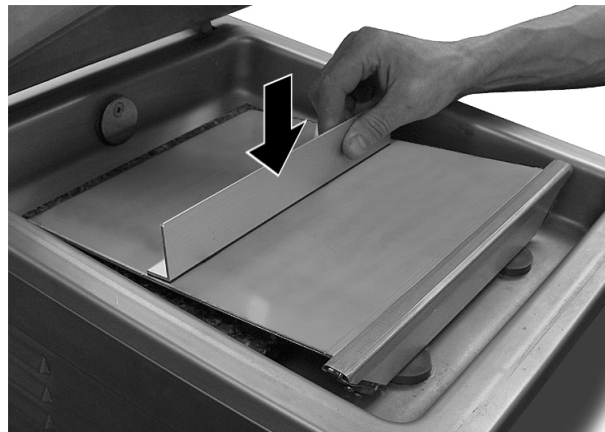

-
- If the sloping insert is no longer needed, remove it, along with the support angle, from the chamber.
-

6 Cleaning



Info

Observe the safety instructions, see Section 1 "SAFETY".
Clean the machine after maintenance work and repairs and disinfect if necessary.

6.1 Notes on cleaning

6.1.1 Rules of conduct

The objective of the cleaning work is to avoid risks to hygiene. If the cleaning is insufficient or not performed properly, this may result in the contamination of the products and to health hazards for end consumers. In addition, the machine may be damaged. Assign only properly instructed and qualified personnel. Information on qualification and training can be obtained from MULTIVAC Service.

The ability to handle materials effectively and efficiently depends on:

- Using the proper dosage of care products.
- Observing the application time of the care products.
- Proper temperature of the mixing water.

Data sheets for the care products can be obtained from their manufacturers. The manufacturers also provide information on the maximum permissible dosages which apply in the food area.

6.1.2 Creating a company cleaning directive

Specify the following points:

- Required cleaning intervals.
- Care products to be used. Care products, refer to "Care products table".
- Using the proper dosage of care products.
- Persons in charge of cleaning.
- First aid measures.

6.1.3 Measures for ensuring a long service life

NOTICE **Danger of material damage!**

Highly acidic or alkaline cleansers that contain chlorine create strong vapours.

These vapours cause corrosion.

- Do NOT use any care products that contain chlorine or are highly acidic or alkaline. Also, do NOT use such care products to clean the machine surroundings.
 - Observe the specifications of the care product manufacturers.
-

NOTICE Danger of material damage!

Acidic cleansers are caustic.

These can cause plastics to become brittle and age prematurely.

- Do NOT shorten the cleaning intervals for acidic cleaning and disinfection.

NOTICE Danger of material damage!

Inappropriate work on anodized aluminium parts causes a damaging of the anodized coating.

This will lead to aluminium corrosion.

- Do not use metal scraping tools.
- Do not use harsh cleansers.
- Do not use cleaning devices with abrasive surface.
- Residues of cleansers and other aggressive deposits must be removed immediately.

Regular and proper care helps to maintain the machine's value. The best protection against harmful influences is to clean and disinfect the machine on a regular basis. The longer product residue and other aggressive deposits remain on the machine, the more harmful their corrosive effects will be.

If used incorrectly, care products can damage components made of rubber or plastic. Before applying care products, please take time to read the instructions and warnings provided by the manufacturer.

6.1.4 Parameters for pre-rinsing and after-rinsing water

- Low pressure of max. 4 bar to 6 bar (58 psi to 88 psi).
- Do not rinse with steam jets or high-pressure cleaners.
- Fan nozzle: 5 ° to 15 ° inclination, approx. 3/16 " nozzle opening.
- Temperature: max. 60 °C (140 °F).
- Quality of after-rinsing water: drinking water quality.

6.1.5 Handling cleansers

Chemical burn hazard!

Cleansers are caustic. Caustic effects are NOT noticed immediately.

Contact with the skin can cause burns.

- Wear the prescribed personal protective equipment when handling cleansers.
- Observe the manufacturer's instructions.

-
- For type of cleander refer to the "Care products table".

- The quantity of cleanser is not the decisive factor for successful cleaning.
 - Applying amounts in excess of the proper dosage does not improve or accelerate cleaning efficiency, but only hinders the required rinsing off of the cleanser.
- Dried cleanser residues make cleaning more difficult and prolonged.
 - Even the smallest residues can inhibit the effect of the disinfection.
 - Check by measuring the pH factor of the post-rinsing water.
- Regular checks of cleaning (i.e. by contact tests) reduces the risk of product contamination.
- Insufficient cleaning cannot be compensated for by doubling the concentration of the disinfectants.

6.1.6 Use with disinfectant



Fire hazard!

Alcohol-based disinfectants are highly flammable. Fire, naked light or smoking ignites the disinfectant and can thus cause fires.

- When disinfecting the machine, flames or naked lights are prohibited.
- Smoking is prohibited.
- Observe the instructions of the disinfectant manufacturer.



Health hazard!

Incorrect use of disinfectant can contaminate the product with chemicals or decrease the effectiveness of disinfection. This can pose serious health hazards for consumers.

- Follow the instructions of the disinfectant manufacturer.
- Only rinse after disinfection if required by disinfectant manufacturer.
- Observe regional hygiene regulations.
- Create a company cleaning guideline.

- For type of disinfectant refer to the "Care products table".
 - For water-sensitive components only use alcohol-based disinfectant.
 - For all other components use disinfectants which are for example based on quaternary ammonium compounds.

6.1.7 Corrosion protection and lubrication

**Health hazard!**

Excess lubricants can accumulate at lubrication points. Excess grease has no lubricating function; however, it can breed micro-organisms and contaminate the product.

- Check the lubricating points regularly for the accumulation of excess lubricants.
- Remove any excess lubricants.

NOTICE Danger of material damage!

Residues of cleansers and disinfectants produce corrosion. Corrosion can destroy the machine.

- After every cleaning, including cleaning of the surroundings (floor, adjacent machines, etc.), thoroughly rinse with water of drinking water quality or clean by hand.

- Kind of anti-corrosion agent, refer to "Care products table".
- Only use H1 or FDA-approved lubricants and anti-corrosion agents.
- Checking the microbiological stability of the anti-corrosion agent and lubricants regularly helps reduce the risk of product contamination.

6.1.8 Cleaning devices

Wet cleaning

**Health hazard!**

The cleaning devices will become germ hot spots if they are not cleaned often enough.

This can cause cross contamination, which will damage the product.

- Use only plastic brushes and brooms.
- Clean the cleaning devices daily and apply disinfectant afterwards.

Dry cleaning

The exhaust air emitted by the vacuum cleaner and whirled up must comply with the prescribed limit values for the packaging environment. Accordingly, the appropriate filter elements must be used in the vacuum cleaner.

6.2 Cleaning the machine



Info

- The recommended daily cleaning tasks recommended here must be supplemented by the intensive cleaning procedure according to the degree of dirt.
- Cleaning personnel must be instructed for the cleaning work by the operating company.
- The sequence of the described tasks is to be followed exactly.

6.2.1 Performing daily cleaning



Info

- The intensive cleaning may only be performed by specially trained personnel.
- The sequence of the described tasks is to be followed exactly.
- In the following, optional equipment versions are also described. Only perform steps that correspond to the version of the machine.
- Always clean the machine from top to bottom.
- For all cleaning work, follow the safety instructions, see Section 6.1 "NOTES ON CLEANING".
- The illustrations are examples.

Preparing for cleaning

-
- Remove all products from the machine.
-
- Switch off the machine.
-
- Disconnect the machine from the mains electricity.
-
- Cover the mains plug with waterproof plastic bags.
-
- Close the stop valve for the gas supply, if part of the machine.
-
- Allow the machine and sealing bars to cool down.
-
- Store empty, new film pouches outside the room in a clean, dry place during the cleaning procedure.
-
- Remove all waste (e.g. product scraps, film trim) on or around the machine.
-

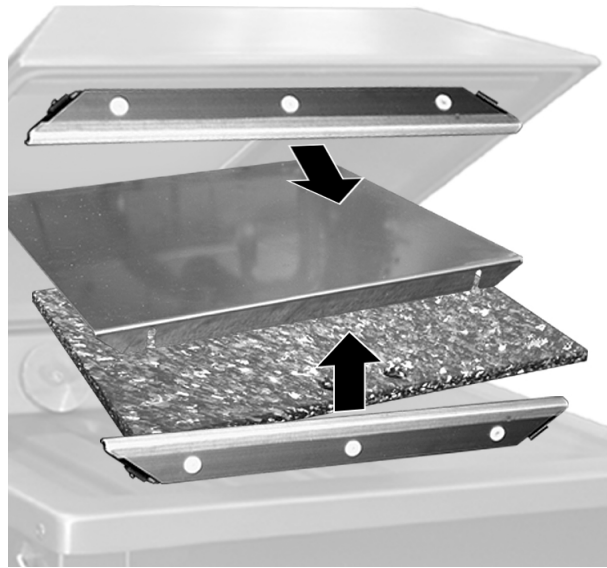

-
- Remove the following components:
 - Diagonal insert with support bracket.
 - Spacer plates.
 - Sealing bars
 - Insertable counter-pressure bar.
-

**Cleaning and
disinfecting dismantled
components**

-
- Take the removed components to a separate room suitable for wet cleaning
-

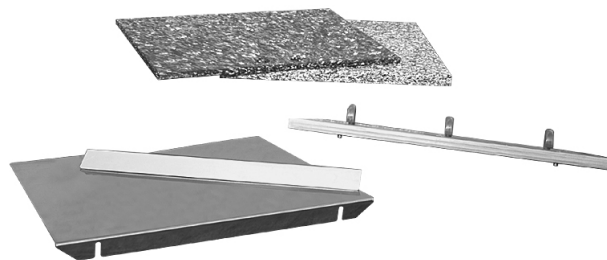

NOTICE Danger of material damage!
The Teflon tape of the sealing bar is very sensitive. Improper cleaning can damage the Teflon tape.

- Clean the Teflon tape only with a soft cloth.
 - Do NOT scratch the Teflon tape.
-
- Clean dismantled components manually with cleaning solution.
 - Thoroughly clean the inert gas nozzles.
-

-
- Wait until the contact time has elapsed (see instructions of cleanser manufacturer).
-
- Wipe with new cloth and water of drinking quality.
-
- Inspect for dirt and cleanser residues.
-
- If necessary, perform another manual cleaning and wipe it off.
-
- Disinfect components with alcohol-based disinfectant:
 - Thoroughly disinfect the inert gas nozzles.
-
- Wait until the contact time has elapsed (see instructions of disinfectant manufacturer).
-

Clean the machine and the floor.

-
- Clean the floor with a rubber wiper.
-
- Dispose of the waste properly.
-
- Apply cleanser to the floor with a low-pressure foaming device.
-
- Wait until the contact time has elapsed (see instructions of cleanser manufacturer).
-
- Rinse off the floor with water of drinking quality.
-

NOTICE Danger of material damage!

Penetration by foreign matter (e.g. liquids, product residue, foreign bodies) will damage the vacuum pump. Damage can cause faults in the machine, which in turn can result in reject packs.

- Do NOT spray directly on the covers of the suction openings in the chamber.
-
- Manually clean the entire machine, including the table, with cleaning solution.
 - Only clean the viewing window in the chamber lid manually with a soft cloth or a soft brush.
-
- Wait until the contact time has elapsed (see instructions of cleanser manufacturer).
-
- Wipe with new cloth and water of drinking quality.
-
- Inspect the entire machine and the floor for dirt and cleanser residues.
-

-
- If necessary, clean and wipe off again.
-

Disinfect the machine and the floor.

NOTICE Danger of material damage!

Penetration by foreign matter (e.g. liquids, product residue, foreign bodies) will damage the vacuum pump.

Damage can cause faults in the machine, which in turn can result in reject packs.

- Do NOT spray directly on the covers of the suction openings in the chamber.
-

- Disinfect entire machine, including table, with alcohol-based disinfectant.
-

- Close chamber lid and lock it in place.
-

- Use a hand-held spray lance to apply disinfectant to the floor.
-

- Wait until the contact time has elapsed (see instructions of disinfectant manufacturer).
-

- If necessary, rinse the floor with water of drinking quality; see instructions of the disinfectant manufacturer.
-

Complete cleaning

-
- Remove the plastic bag from the mains plug.
-

- Dispose of plastic bags properly. For reasons of hygiene, never reuse bags
-

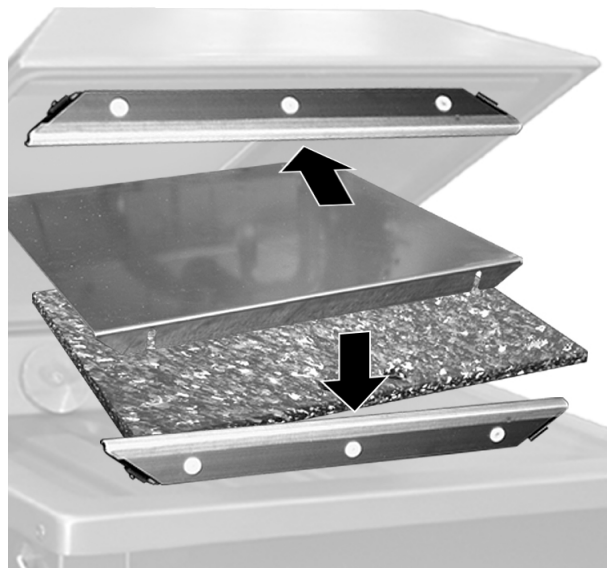

-
- Attach the following components:
 - Insertable counter-pressure bar.
 - Sealing bars
 - Spacer plates.
 - Diagonal insert with support bracket.
-
- Disinfect the entire loading area with alcohol-based disinfectant.
-
- Leave the chamber lid open to dry.
-
- If present, open the stop valve for the gas supply.
-
- Connect the machine to the mains electricity.
-
- Clean cleaning implements (e.g. rubber wipers, brushes).
-
- Place cleaning implements in disinfectant solution-
-
- Unpack the film pouches and lay them ready.
-

6.2.2 Performing intensive cleaning



Info

- Intensive cleaning complements daily cleaning. As part of this process additional cleaning measures are required depending on the degree of contamination of the components described in this chapter.
- The intensive cleaning may only be performed by specially trained personnel. Information on qualifications and training can be obtained from our service personnel.
- The sequence of the described tasks is to be followed exactly.
- Always clean the machine from top to bottom.
- In the following, optional equipment versions are also described. Only perform steps that correspond to the version of the machine.
- For all cleaning work, follow the safety instructions, see Section 6.1 "NOTES ON CLEANING".
- The illustrations are examples.



-
- Remove chamber lid gasket from the groove.
-
- Perform daily cleaning, see Section 6.2.1 "PERFORMING DAILY CLEANING".
 - Clean and disinfect the chamber lid gasket together with the removed components.
-



-
- Insert the dry chamber lid gasket in the groove of the lid.
 - If the chamber lid gasket or groove is wet, dry with a new cloth or sterile compressed air.
-



Info

During insertion, do not stretch the gasket.



-
- Smooth out gasket.
-
- Disinfect gasket with alcohol-based disinfectant.
-
- Switch on the machine.
-
- Close and press down the chamber lid and observe the pressure shown in the display.
 - The pressure drops: the chamber is airtight.
 - The pressure does not drop: the chamber is not airtight.
-
- If the chamber is not airtight, check the chamber lid gasket:
 - Smooth out gasket.
-

- Disinfect gasket with alcohol-based disinfectant.
 - Wait until the contact time has elapsed (see instructions of disinfectant manufacturer).
-
- Switch off the machine.
-

6.3 Care products table

Recommended care products:

Type	Manufacturer	Designation	
Cleansers, neutral	Ecolab Europa	P3-topax 12	
	Ecolab USA	Quorum Pink II	
	Diversey Europe		Shureclean VK10
			JD Shureclean Plus VK9
	Diversey USA		Shureclean VK10
			JD Shureclean Plus VK9
Cleansers, alkaline	Ecolab Europa	P3-topactive LA	
	Diversey Europe		JD Ultraclean VK3
			Diverfoam SMS HD VF22
	Diversey USA		JD Ultraclean VK3
			Diverfoam SMS HD VF22
	Cleansers, acidic	Ecolab Europa	P3-topax 52
P3-topax 56			
Ecolab USA			Quorum Red
			Foam shine
Diversey Europe			JD Acifoam VF10
Diversey USA			
Disinfectants	Ecolab Europa	P3-topax 91	
		P3-topax 990	
	Ecolab USA		Ster-Bac
	Diversey Europe		JD Divosan extra VT55
			JD Suredis VT1
	Diversey USA		JD Divosan extra VT55
			JD Suredis VT1
	Disinfectants (alcohol-based)	Ecolab Europa	P3-alcodes

Type	Manufacturer	Designation
	Diversey Europe	JD Divodes FG VT29
	Diversey USA	
Anti-corrosion agents	Esso	Primol 352
	Castrol	Optimol F+D Fluid Spray
	Klüber Lubrication	Klüberfood NH1 K 32
Stainless steel care products	Ecolab Europa	P3-proguard MC

All recommended anti-corrosion agents and stainless steel care products are food compatible.

Buying source:

- Ecolab: www.ecolab.com
- Diversey: www.diversey.com
- Esso: www.exxonmobil.com
- Castrol: www.castrol.com
- Klüber Lubrication: www.klueber.com

7 Maintenance



Dangerous voltage!

Switching off the machine does not rid it of electrical current. Touching electrically charged components can cause serious or even fatal injuries.

Before performing any cleaning or service work:

- Disconnect the machine's power supply from the mains electricity.
- Have work in the control cabinet performed by authorised technicians only.



Info

Observe the safety instructions, see Section 1 "SAFETY". Clean the machine after maintenance work and repairs and disinfect if necessary.

7.1 Maintenance schedule

As needed

		Page	Completed
Entire machine	Perform a wipe test	68	

Every 8 operating hours or daily

		Page	Completed
Vacuum pump	Perform the pump protection function	68	
Entire machine	Visual inspection	68	
Entire machine	Alkaline cleaning and disinfection	69	
Vacuum pump	Checking oil level, topping up	69	

Every 50 operating hours or weekly

		Page	Completed
Entire machine	Acidic cleaning and disinfection	69	
Connections	Visual inspection	69	
Vacuum system	Check	69	

		Page	Completed
Every 1000 operating hours or yearly			
		Page	Completed
Vacuum pump	Oil change	69	
Vacuum pump	Exchanging the air de-oiling element	69	
Entire machine	Check the age	70	

7.2 Maintenance recommendation

7.2.1 Entire machine - Perform a wipe test

- Check the result of the cleaning and disinfection by means of a wipe test.
See the company cleaning guidelines and recommendations.

7.2.2 Vacuum pump - Perform the pump protection function

- Perform the pump protection function, for this switch off the machine, see Section 4.2 "SWITCHING OFF THE MACHINE".

7.2.3 Entire machine - Visual inspection

- Check the entire machine exterior for damage.
- Check that all safety labels are present.
- Check that all safety devices are attached and undamaged.
- Check the viewing window in the chamber lid for damage (e.g scratches, cracks).
 - If the viewing window in the chamber lid is damaged have it replaced immediately by the manufacturer.
- Check chamber lid gasket for damage.
 - Have the chamber lid gasket replaced by the service department if necessary.
- Check sealing bar for damage.

-
- If necessary, replace the sealing bar, see Section 7.4 "REPLACE THE SEALING BAR".
-

- Check the counter-pressure bar for damage.
 - If necessary, repair the counter-pressure bar,.
-

7.2.4 Entire machine - Alkaline cleaning and disinfection

- See company cleaning guidelines and.
-

7.2.5 Vacuum pump - Checking oil level, topping up

- Check the oil level on the oil sight glass.
 - If water is present in the oil, change the oil in the vacuum pump, see Section 7.5 "CHANGE THE OIL IN THE VACUUM PUMP".
 - If necessary, refill oil,.
-

7.2.6 Entire machine - Acidic cleaning and disinfection

- See company cleaning guidelines and.
-

7.2.7 Connections - Visual inspection

- Disconnect the machine from the mains electricity.
 - Check power cable for damage.
 - If present, check that the supply line for inert gas is fitted tightly and undamaged.
-

7.2.8 Vacuum system - Check

- Perform a vacuum test, see Section 7.3 "PERFORMING THE VACUUM TEST".
-

7.2.9 Vacuum pump - Oil change

- Change the oil in the vacuum pump, see Section 7.5 "CHANGE THE OIL IN THE VACUUM PUMP".
-

7.2.10 Vacuum pump - Exchanging the air de-oiling element

- Change the air de-oiling element,.
-

7.2.11 Entire machine - Check the age

- Read the year of manufacture on the type plate.
 - If the machine is older than 19 years:
 - Shut down the machine.
 - Have the safety functions checked by MULTIVAC Service.
-

7.3 Performing the vacuum test

- Call up the "Service" menu.
 - Call up the "test" menu.
 - Select *Vacuum test*.
 - Switch on the *vacuum test*.
 - Return to the status display.
 - Close and press down the chamber lid.
 - The evacuation system is being checked.
 - The processes in the machine run automatically.
 - The corresponding diagnostic message appears.
 - The chamber lid opens.
 - Acknowledge the diagnostic message.
 - The vacuum test is switched off.
 - If the vacuum test is not successful, see the displayed diagnostic message to correct the fault, see Section 8 "TROUBLESHOOTING".
-

7.4 Replace the sealing bar

7.4.1 Remove the sealing bar

- Switch off the machine.
 - Disconnect the machine from the mains electricity.
 - Open the chamber lid.
 - Let the sealing bar cool down.
 - Pull out the sealing bar.
-



7.4.2 Install the sealing bar

- Disconnect the machine from the mains electricity.
- Install the sealing bar on the carriers.



- Install the sealing bar in such a way that the screws on the sealing bar point to the middle of the chamber.

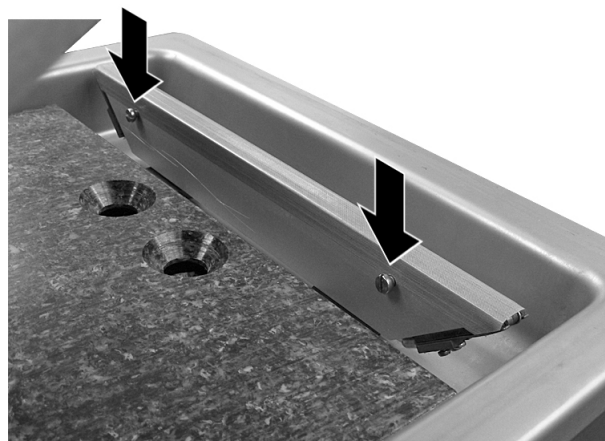

7.5 Change the oil in the vacuum pump

7.5.1 Drain oil

- Switch off the machine.
- Disconnect the machine from the mains electricity.



WARNING

Burn hazard!

The surface of the vacuum pump can reach temperatures of over 70 °C during operation.

Touching the vacuum pump can lead to burns.

Before performing any work on the vacuum pump:

- Allow the vacuum pump to cool down.
 - Wear personal protective equipment.
-
- Unscrew the screws on the safety guard and remove the safety guard.
-
- Allow the vacuum pump to cool down.
-
- Hold a container to catch the oil under the drain opening (e.g. an empty oil bottle).
-
- Unscrew the screw plug of the drain opening.
-
- Drain the oil completely.
-
- Replace the sealing ring in the screw plug.

-
- Insert the screw plug with the sealing ring in the drain opening and screw it tight.
-
- Dispose of old oil properly.
-
- Fill new oil into the vacuum pump, see Section 7.5.2 "ADDING OIL TO THE VACUUM PUMP".
-
- Fasten the safety guard with the screws.
-

7.5.2 Adding oil to the vacuum pump

-
- Switch off the machine.
-
- Disconnect the machine from the mains electricity.
-



Burn hazard!

The surface of the vacuum pump can reach temperatures of over 70 °C during operation.

Touching the vacuum pump can lead to burns.

Before performing any work on the vacuum pump:

- Allow the vacuum pump to cool down.
- Wear personal protective equipment.

-
- Unscrew the screws on the safety guard and remove the safety guard.
-
- Allow the vacuum pump to cool down.
-
- Unscrew the screw plug of the oil fill opening.
-

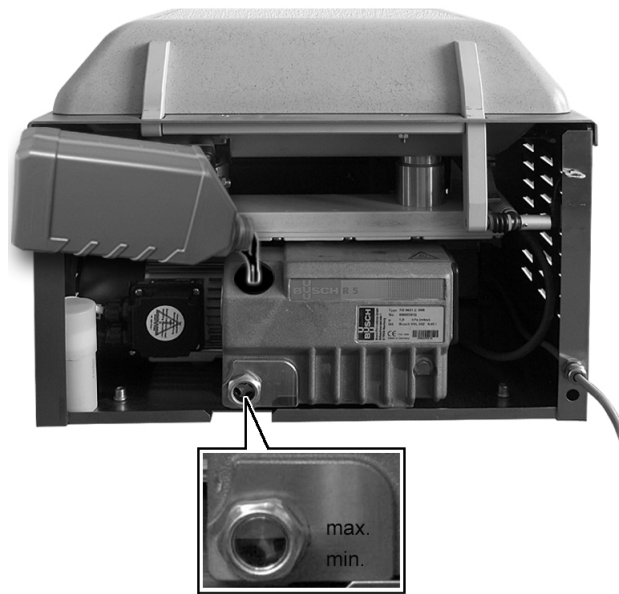

-
- Fill the vacuum pump with oil up to the middle of the oil sight glass. Use only oils that are approved by the manufacturer, see 'Spare Parts' section or the spare parts list.
-

**Info**

Only use low odour synthetic oil if foodstuffs are being packed.

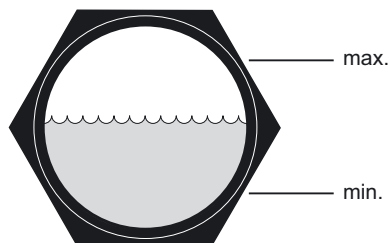

-
- Check oil level on the oil sight glass:
 - The oil level should reach the middle of the oil sight glass.
 - If oil level is under the MIN mark, add oil.
 - Replace the sealing ring in the screw plug.
 - Insert the screw plug with the sealing ring in the fill opening and screw it tight.
 - Fasten the safety guard with the screws.
 - Connect the machine to the mains electricity.
 - Switch on the machine.
 - Check the oil level after a couple of machine cycles.
-

8 Troubleshooting



Injury hazard!

Ignorance of proper machine handling is very dangerous. Improper handling can lead to serious injuries.

For all service and repair work:

- Make sure you observe the safety instructions and accident prevention regulations.
- Disconnect the unit's power supply from the mains electricity.
- Only qualified electricians are permitted to work on electrical modules.
- Service and repair work should be carried out by authorised technicians only.

8.1 Malfunctions with diagnostic message

Symptom	Cause	Solution
67	• Vacuum pump does not switch off.	• Notify the service.
	• Ventilation valve does not open.	• Notify the service.
68	• No gas available or near end.	• Connect inert gas or ensure that there is sufficient gas supply (e.g. change gas bottle).
	• Stop valve for the gas supply is closed.	• Open the stop valve for the gas supply.
	• Gas hose has a kink in it.	• Remove the kink in the gas hose.
	• Value for the <i>gas flushing pressure</i> is set such that it cannot be reached.	• Correct the value for <i>Gas flushing pressure</i> .
	• The vacuum sensor is incorrectly calibrated.	• Notify the service.
	• Vacuum sensor is defective.	• Notify the service.
	• Gas valve does not open.	• Notify the service.
69	• Value for the <i>Evacuation pressure</i> is set so low that it cannot be reached.	• Correct the value for <i>Evacuation pressure</i> .

Symptom	Cause	Solution
	<ul style="list-style-type: none"> Vacuum hose between the chamber and the vacuum sensor is clogged, missing or leaking. 	<ul style="list-style-type: none"> Notify the service.
	<ul style="list-style-type: none"> Vacuum hose is loose, leaking or clogged. 	<ul style="list-style-type: none"> Notify the service.
	<ul style="list-style-type: none"> Chamber lid gasket is not air-tight. 	<ul style="list-style-type: none"> Notify the service.
	<ul style="list-style-type: none"> Vacuum sensor is defective. 	<ul style="list-style-type: none"> Notify the service.
	<ul style="list-style-type: none"> Vacuum pump is not being triggered or the vacuum pump is defective. 	<ul style="list-style-type: none"> Notify the service.
	<ul style="list-style-type: none"> Vacuum pump is leaky. 	<ul style="list-style-type: none"> Notify the service.
	<ul style="list-style-type: none"> Filter in the line to the vacuum sensor is dirty and blocked. 	<ul style="list-style-type: none"> Notify the service.
80	<ul style="list-style-type: none"> Leak in hose connections. 	<ul style="list-style-type: none"> Notify the service.
	<ul style="list-style-type: none"> Leak in vacuum hose. 	<ul style="list-style-type: none"> Notify the service.
	<ul style="list-style-type: none"> The vacuum sensor and associated line is leaking. 	<ul style="list-style-type: none"> Notify the service.
81	<ul style="list-style-type: none"> Sealing diaphragm leaks. 	<ul style="list-style-type: none"> Notify the service.

8.2 Faults without diagnostic message

Symptom	Cause	Solution
Machine does not run.	<ul style="list-style-type: none"> Machine is switched off. 	<ul style="list-style-type: none"> Switch on the machine.
	<ul style="list-style-type: none"> Mains plug is unplugged. 	<ul style="list-style-type: none"> Plug in the mains plug.
	<ul style="list-style-type: none"> Ambient temperature too low. 	<ul style="list-style-type: none"> Operate the machine only at permissible ambient temperature, see "Technical Specifications".
Chamber lid does not remain closed despite pump running.	<ul style="list-style-type: none"> Chamber lid pressed closed too briefly. 	<ul style="list-style-type: none"> Press the chamber lid shut more evenly, more firmly and for longer.
	<ul style="list-style-type: none"> Chamber lid gasket is dirty. 	<ul style="list-style-type: none"> Clean the chamber lid gasket.
	<ul style="list-style-type: none"> Chamber lid gasket is damaged. 	<ul style="list-style-type: none"> Change chamber lid gasket.
Poor vacuum in the pack.	<ul style="list-style-type: none"> <i>Evacuation pressure</i> is set too high. 	<ul style="list-style-type: none"> Reduce <i>Evacuation pressure</i> value.

Symptom	Cause	Solution
	<ul style="list-style-type: none"> • <i>Gas flushing pressure</i> is set too high. 	<ul style="list-style-type: none"> • Reduce <i>Gas flushing pressure</i> value.
	<ul style="list-style-type: none"> • <i>Gas flushing time</i> is set too high. 	<ul style="list-style-type: none"> • Reduce <i>Gas flushing time</i> value.
	<ul style="list-style-type: none"> • Pouch neck is clamped by chamber lid. 	<ul style="list-style-type: none"> • Insert the film pouch so that the pouch neck lies within the chamber. Cut off the pouch neck if necessary.
	<ul style="list-style-type: none"> • Chamber lid gasket is dirty. 	<ul style="list-style-type: none"> • Clean the chamber lid gasket.
	<ul style="list-style-type: none"> • Insufficient oil quantity or oil in the vacuum pump is too old. 	<ul style="list-style-type: none"> • Refill or replace oil.
	<ul style="list-style-type: none"> • Chamber lid gasket is damaged. 	<ul style="list-style-type: none"> • Change chamber lid gasket.
	<ul style="list-style-type: none"> • Moist or liquid products give off steam during the evacuation process. 	<ul style="list-style-type: none"> • Abort the evacuation process with the <Stop> key in case the chamber lid mists up. • Pack product with the <i>Automatic</i> function. Set the value for the <i>Automatic sensitivity</i>.
	<ul style="list-style-type: none"> • Evacuation system is leaking. 	<ul style="list-style-type: none"> • Notify the service.
Pack is leaking.	<ul style="list-style-type: none"> • Sealing time is set incorrectly. 	<ul style="list-style-type: none"> • Increase the value for <i>Sealing time</i> in small increments.
	<ul style="list-style-type: none"> • Pouch neck is clamped by chamber lid. 	<ul style="list-style-type: none"> • Insert the film pouch so that the pouch neck lies within the chamber. Cut off the pouch neck if necessary.
	<ul style="list-style-type: none"> • Seal seam is dirty. 	<ul style="list-style-type: none"> • Keep the inside of the film pouch in the area of the seal seam clean.
	<ul style="list-style-type: none"> • Film pouch damaged. 	<ul style="list-style-type: none"> • Use a new film pouch.
	<ul style="list-style-type: none"> • Film pouch not suitable. 	<ul style="list-style-type: none"> • Use a film pouch suitable for sealing.
	<ul style="list-style-type: none"> • Pouch neck is clamped by chamber lid. 	<ul style="list-style-type: none"> • Insert the film pouch so that the pouch neck lies within the chamber.
	<ul style="list-style-type: none"> • Film pouch not suitable. 	<ul style="list-style-type: none"> • Use a film pouch suitable for sealing.

Symptom	Cause	Solution
	<ul style="list-style-type: none"> The pressure difference between the chamber and the outside environment is not large enough before the sealing process. 	<ul style="list-style-type: none"> Reduce <i>Evacuation pressure</i> value. Reduce <i>Gas flushing pressure</i> value. Reduce <i>Gas flushing time</i> value.
	<ul style="list-style-type: none"> Sealing bar damaged. 	<ul style="list-style-type: none"> Replace sealing bar.
Seal seam is uneven and wavy.	<ul style="list-style-type: none"> The pressure difference between the chamber and the outside environment is not large enough before the sealing process. 	<ul style="list-style-type: none"> Reduce <i>Evacuation pressure</i> value. Reduce <i>Gas flushing pressure</i> value. Reduce <i>Gas flushing time</i> value.
	<ul style="list-style-type: none"> Teflon tapes on the sealing bar and counter-pressure bar are worn. 	<ul style="list-style-type: none"> Change the Teflon tapes.
	<ul style="list-style-type: none"> Profile thread in the counter-pressure bar is worn. 	<ul style="list-style-type: none"> Repair the counter-pressure bar.
Seal seam is milky.	<ul style="list-style-type: none"> Sealing time is set incorrectly. 	<ul style="list-style-type: none"> Reduce the <i>Sealing time</i> value. The seal seam should be clear and transparent.
The excess pouch neck can only be severed with difficulty at the sever seal or it can not be severed at all.	<ul style="list-style-type: none"> Sealing time is set incorrectly. 	<ul style="list-style-type: none"> Increase the value for <i>Sealing time</i> in small increments.
Odour or smoke.	<ul style="list-style-type: none"> Air de-oiling element is defective. 	<ul style="list-style-type: none"> Change air de-oiling element.
	<ul style="list-style-type: none"> Oil return valve of vacuum pump is clogged. 	<ul style="list-style-type: none"> Notify the service.
Machine is very loud.	<ul style="list-style-type: none"> Air de-oiling element clogged. 	<ul style="list-style-type: none"> Change air de-oiling element.
	<ul style="list-style-type: none"> Vacuum pump defective. 	<ul style="list-style-type: none"> Notify the service.
High oil consumption.	<ul style="list-style-type: none"> Air de-oiling element clogged. 	<ul style="list-style-type: none"> Change air de-oiling element.
Oil leaks out of machine.	<ul style="list-style-type: none"> Screw plugs or oil sight glass not tight. 	<ul style="list-style-type: none"> Tighten screw plugs and oil sight glass.
	<ul style="list-style-type: none"> Vacuum pump defective. 	<ul style="list-style-type: none"> Notify the service.

9 Shutdown, transport, storage



Info

Observe the safety instructions, see Section 1 "SAFETY".

9.1 Taking the machine out of service

- Disconnect the machine from the mains electricity.
 - If present, close the stop-cock for the gas supply and detach the gas hose from the inert gas connection.
 - Clean machine and then preserve it,.
 - Close chamber lid and lock it in place.
-

9.2 Transporting the machine

9.2.1 Transporting the machine

- Wear personal protective equipment.



Injury hazard!

The machine is heavy.

Carrying the machine can cause injuries.

- Have a second person assist you.
-

NOTICE Danger of material damage!

At an inclination of more than 15°, the oil in the vacuum pump shifts.

The air de-oiling elements will get wet from the oil and become ineffective. This will damage the vacuum pump.

- Transport and set the machine down as horizontally as possible.
 - Do NOT tilt the machine.
-
- Carefully raise the machine.
 - For machine dimensions and weight, see "Technical specifications".
 - Transporting the machine
 - Avoid severe jolts.
-

9.3 Storing the machine

- Shutting down the machine.

 - Select a suitable storage site.
 - Observe the ambient conditions for storing the machine, see Technical specifications.
 - Ensure that the location site is of adequate load-bearing capacity and keep the weight of the unit in mind, see Technical specifications.

 - If necessary, cover the machine with film.
-

10 Disposal

10.1 Disposing of the machine



Info

- Sealing bars can be reused on other machines of the same series.
- If disposal of the machine is not handled by the manufacturer, dispose of the machine as described below.

➤ Disconnect the machine from the mains electricity, see Section 9 "SHUTDOWN, TRANSPORT, STORAGE".

➤ Dispose of the materials properly, observing all legal and company-internal regulations regarding environmental protection.

10.2 Dispose of operating materials

10.2.1 Disposing of oil and grease

NOTICE **Protect the environment!**

Operating materials and working equipment are environmentally harmful.

Improper disposal is harmful to the environment.

- Handle operating materials and working equipment properly.
- Dispose of operating materials and working equipment at suitable collection points.
- Observe the environmental directives.

➤ Handle operating materials and working equipment properly and dispose of them in a professional manner.



Info

Excerpt from the disposal directive:

- It is prohibited to mix used oil with other waste.
- Used oils may NOT be mixed with each other.
- Used oil filters should be collected, stored, transported and disposed of separately from other waste.

10.2.2 Disposing of packaging materials



Info

Packaging materials are resource materials that can be recycled.

- Improper disposal is harmful to the environment.
- Films should be collected for recycling.
- Follow the disposal instructions of the packaging material manufacturer.

-
- Handle packaging materials properly and dispose of them in a professional manner.
-



Info

Packaging materials are resource materials that can be recycled.

- Improper disposal is harmful to the environment.
- Films should be collected for recycling.
- Follow the disposal instructions of the packaging material manufacturer.

10.2.3 Dispose of chemicals



Chemical burn hazard!

Cleansers are caustic. Caustic effects are NOT noticed immediately.

Contact with the skin can cause burns.

- Wear the prescribed personal protective equipment when handling cleansers.
 - Observe the manufacturer's instructions.
-



Fire hazard!

Alcohol-based disinfectants are highly flammable.

Fire, naked light or smoking ignites the disinfectant and can thus cause fires.

- When disinfecting the machine, flames or naked lights are prohibited.
 - Smoking is prohibited.
 - Observe the instructions of the disinfectant manufacturer.
-

- Handle cleansers and disinfectants properly and dispose of them in a professional manner.
-



Info

Improper disposal is harmful to the environment.

- Observe the safety data sheets of the cleanser and disinfectant manufacturers.
- Follow the disposal instructions of the cleanser and disinfectant manufacturers.
- Observe regionally applicable disposal regulations.

11 Spare parts

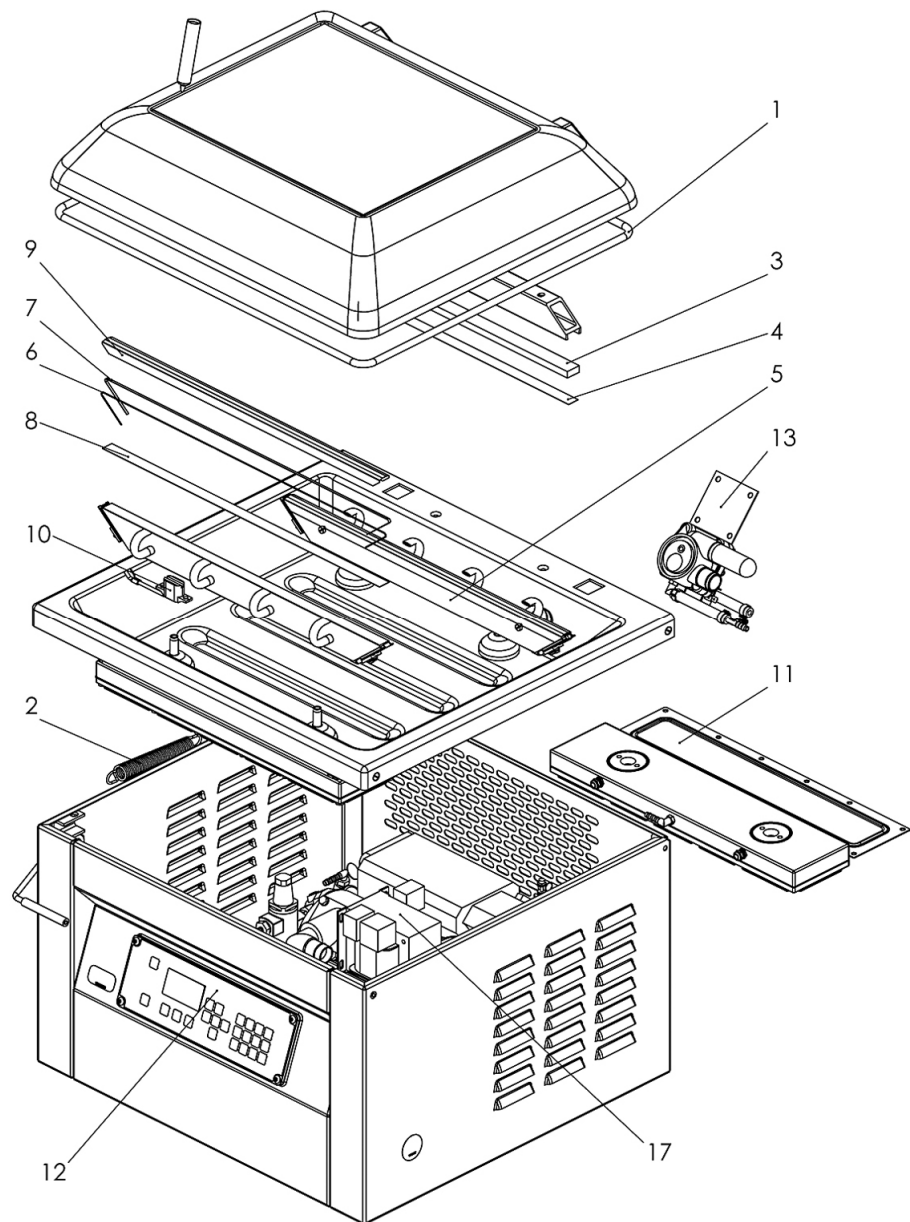

Fig. 33: Spare parts drawing (SAP-DIS 16000134755)

Item	Material number	Designation	Quantity and unit of measurement
1	105893127	Round cord (chamber lid gasket), for chamber height 150 mm	2.0 m

Item	Material number	Designation	Quantity and unit of measurement
2	101643292	Tension spring	1 pc.
3	81863151040	Profile thread	1.0 m
4	81848121000	Teflon tape 0.13 mm x 16 mm	1.0 m
5	105174192	Sealing bar, complete	2 pc.
6	11131198180	Heating tape 3 mm	2 pc.
7	85662802090	Round wire	1.3 m
8	81848121001	Teflon tape 0.25 mm x 16 mm	1.22 m
9	81848121006	Teflon tape 0.13 mm x 40 mm	1.0 m
10	85123126100	Contact bushing	4 pc.
11	105685137	Diaphragm	2 pc.
12	105326253	Control	1 pc.
13	11181798040	Diaphragm	1 pc.
14	105048117	Low odour synthetic oil for vacuum pumps (food grade)	1 l
14	91111114013	HD mineral oil (not food grade)	1 l
15	105865631	Air de-oiling element for vacuum pump RB 0021 B	1 pc.
16	11131117103	Repair kit (contains items 6, 7, 8, 9)	2 pc.
17	85641281115	Transformer 220_240/20 volt	1 pc.
17	85641281117	Transformer 110/20 volt	1 pc.

Glossary

Automatic	<p>If the function <i>Automatic</i> is set, the machine will reach the optimum evacuation time and pressure depending on the product. The automatic evacuation is suitable for the following cases:</p> <ul style="list-style-type: none">• Achieving the best possible vacuum for long shelf life.• Packing of products for which the optimum evacuation pressure is not known.• Packing of the same product but one which has varying properties (e.g. varying moisture content, varying temperature). <p>If the evacuation is automatic the value for <i>Automatic sensitivity</i> can be adapted to the product.</p>
Automatic sensitivity	<p>Determines the evacuation time and the evacuation pressure reached when evacuating with the <i>Automatic</i> function. The sensitivity is adjustable from 1 to 10. The lower the sensitivity, the lower the evacuation pressure reached. The value for <i>Automatic sensitivity</i> is dependant on the product.</p> <p>High value for <i>Automatic sensitivity</i> (value 10):</p> <ul style="list-style-type: none">• Is suitable for very moist or fluid products.• Evacuation process ends early.• Evacuation pressure reached in the pack is high. <p>Low value for <i>Automatic sensitivity</i> (value 1):</p> <ul style="list-style-type: none">• Is suitable for dry products.• Evacuation process ends late.• Evacuation pressure reached in the pack is low.
Cooling down Sealing	<p>Value for the cooling down time of the seal seam. The vacuum in the chamber and the sealing pressure are maintained for this length of time. The seal seam can harden. The sealing is switched off during this time.</p>
Cycle time	<p>The display contains the times of the individual procedures of the last packaging procedure.</p>
Delayed ventilation - Sealing	<p>The ventilation of the chamber begins with a delay after sealing.</p>
Distribution time - evacuation	<p>Switching interval between the completed evacuation process and the beginning of the gas flushing process. During the distribution time remaining air pockets in the products can escape before the package is sealed.</p>
Distribution time - Gas flushing	<p>Switching interval after the gas flushing process, during which the gas can distribute itself in the the film pouch.</p>

Evacuation pressure	<p>Is the pressure to which the film pouch and the chamber are evacuated. The pressure is measured in the chamber. Evacuation to a pre-determined pressure is suitable for the following cases:</p> <ul style="list-style-type: none">• Achieving a package result which is different from that of the optimum evacuation pressure.• Packing of products for which the optimum evacuation pressure is known.• Packing of the same product which has identical properties.
Fill diaphragm	<p>During this time sealing pressure is applied to the sealing diaphragm.</p>
Gas flushing pressure	<p>Indicates the pressure until the film pouch is filled with inert gas. Pressure is measured in the chamber.</p>
Gas flushing time	<p>Indicates the amount of time for which the film pouch will be filled with inert gas. Pressure is not influenced by this.</p>
Hours of operation	<p>Shows the time the machine has been operating. The counter begins to count as soon as the machine is switched on and can not be reset.</p>
Machine cycles	<p>Counts the number of complete machine cycles. The counter can be modified and reset. It is used to control the quantities produced.</p>
MCV duration	<p>During this time the set vacuum is maintained during the MCV process (Pressure value + threshold).</p>
MCV threshold	<p>If the pressure value set here is exceeded during the MCV process, further evacuation automatically takes place.</p>
Post-evacuation time	<p>This time extends the evacuation process. Through this, the reached evacuation pressure is lower than the set value. This time begins, when the set pressure is reached. Suitable for damp products.</p>
Rinsing time, gas flushing	<p>During this time the vacuum valve and gas valve are opened simultaneously. On one side of the chamber a vacuum is created, on the other side gas is supplied. The film pouch is thoroughly flushed with gas. This reduces the residual oxygen content.</p>
Sealing time	<p>During this time the film pouch is sealed. The sealing time depends on the material and the thickness of the film pouch.</p>
Sealing time max	<p>This time determines the maximum value for the sealing time.</p>
Settings - Production Data	<p>Shows all currently set target values.</p>
total cycles	<p>Shows the completed machine cycles.</p>

Vacuum pump - Production data	Counts the vacuum pump's hours of operation. Counting starts as soon as the vacuum pump is turned on. The display cannot be changed.
Vacuum test	Automatic leakage test of the vacuum system and the sealing diaphragm.
Ventilate diaphragm	During this time the sealing diaphragm is evacuated. The sealing is without sealing pressure.

Index

A

Access authorisations, selecting 46
Access right 46
Access right, resetting 46
Access rights 31
Access, blocking 46
Adjustment work 53
Against regulations 13
Air de-oiling element 38, 79
Air humidity 35
Airtightness testing 33
Ambient conditions 35
Ambient temperature 35
Anti-corrosion agents 57
Automatic 86
Automatic evacuation 86
Automatic sensitivity 86

B

Basic cleaning 40
Basic settings 50
Buying source 66

C

Calling up menus 45
Care products table 65
Chamber 25
Chamber lid 25
Chamber lid gasket 25
Chamber size 35
Change password 46
Cleaning 58
Cleaning device 57
Cleansers 55
Configuration code 29
Control terminal 25, 27
Cooling down Sealing 86
Corrosion protection 57
Counter-pressure bar 25
Cycle time 86

D

Daily cleaning, performing 58
Delayed ventilation - sealing 86
Depth 35
Diagnostic display 31
Diagnostic message 75

Diagnostic message, acknowledging 28
Diagnostic number 31
Dimensions 34
Disinfectant 56
Disinfection 58
Display 28
Display cycle time 51
Display hours of operation 51
Display production data 51
Display total cycles 51
Display, setting 52
Disposal directive 81
Dispose of chemicals 82
Disposing of the machine 81
Distribution time - evacuation 86
Distribution time - gas flushing 86
Drying packaging 33

E

EMC 13
Entering basic settings 50
Error 31
Error number 31
Evacuation Pressure 87
Evacuation process, cancelling 28
Evacuation, automatic 86

F

Factory setting 48
Faults 76
Fill diaphragm 87
Film, disposal 82

G

Gas flushing pressure 87
Gas flushing process, cancelling 28
Gas flushing time 87
Gas nozzle 25
Gas purging 87
Gas supply 17
Grease disposal 81

H

Hazards, avoiding 16
Height 34, 35
High-pressure cleaners 55
Hygiene 18
Hygiene standard 18

I

Incorrect use 14
Inert gas 36
Inert gas connection 26
Inert gas, connecting 39
Information labels 22
Inputs, sealing 50
Installation conditions 35
Installation location 16
Instructions to follow 8
Intended use 13
Intensive cleaning, performing 63
IT network 16

K

Key 27

L

Label 21
Language selection 47
Load recipe 47
Load recipe quickly 48
Lock 29
Locking for lid 25
Login 46
Low-pressure test 19

M

Machine control 27
Machine cycles 87
Machine cycles, modifying 50
Machine cycles, resetting 50
Machine labels 21
Machine shutdown 80
Machine storage 80
Machine, cleaning 58
Machine, disinfecting 58
Machine, monitoring 15
Machine, switching off 41
Machine, switching on 41
Machine, transporting 79
Machine's hours of operation 51
Mains voltage 34, 39
Maintenance recommendation 68
Malfunctions 75
Manufacture of spare parts 11
Max. short-circuit current 34
Maximum pre-fuse 34
MCV 33
MCV Duration 87
MCV threshold 87

Measurement of residual oxygen 19
Menu tree 32
Misuse 13
Modifications 11
Monitoring obligation 15

N

Noise exposure 36
Nominal current 34
Nominal power 34
Non-ionising radiation 13

O

Oil disposal 81
Oil level 74
Oil sight glass 26
Oil, adding 73
Oil, changing 72
Oil, draining 72
Operating company, obligation 14
Operating directive, creating 14
Operating electrical circuit 16
Operating height 35
Operating hours 87
Operating materials 81

P

Pack, checking 18
Packaging process 33
Packing products 42
Parameters, setting 45
Password 46
Performing daily disinfection 58
Personal protective equipment 16
Personnel, training 15
Phases 34
Post evacuation time 87
Power supply 16
Power supply connection 26, 34
Power supply, connecting 39
pre-fuse 34
Preset recipes 33
Pressure equipment, testing 20
Process data 29
Process data status display 29
Process sequence 32
Production data 87
Program 47
Protection type 34
Protective equipment 16
Pump protection function 19

Purging time gas flushing 87

R

Reasonably foreseeable incorrect use 13

Recipe 47

Recipe keys 48

Recipe, deleting 49

Recipe, saving 48

Recipes 33

Relative air humidity 35

Requirements, gas supply 17

Reset password 47

Residual current protective device 16

Residual risks 14

S

Safety devices 20, 21

Safety instructions 9

Safety labels 22

Scope of delivery 6

Screw plug, drain opening 26

Screw plug, fill opening 26

Seal seam strength 19

Seal seam width 18

Sealing 50

Sealing bar 25

Sealing bar, installing 71

Sealing bar, removing 70

Sealing bar, replacing 70

Sealing length 35

Sealing procedure, cancelling 28

Sealing time 87

Sealing time max 87

Sealing, setting 50

Select process 49

Selection of personnel 15

Sensitivity 86

Set MCV 49

Set process 49

Set standard 49

Setting up the machine 38

Settings - Production data 87

Setup 53

Short-circuit current 34

Show settings 51

Sloping insert, inserting 53

Sloping insert, removing 53

Software version 29, 41

Spare parts 84

Stacking test 19

Standard process 33

Startup display 28

Status display 29

Steam jets 55

Storage temperature 35

Storage test 19

Symbols 7

T

Taking machine out of service 79

Target group 9

Target values 87

Technical data 34

Technical products 33

Testing procedure 18

Third-party part 14

TN-S network 16

Total cycles 51, 87

Transport 79

Transport equipment 79

Troubleshooting 75

Type designation of machine control 29

V

Vacuum pump 36, 38, 79

Vacuum pump - production data 88

Vacuum pump hours of operation 51

Vacuum test 88

Vacuum test, performing 70

Values, changing 45

Ventilate diaphragm 88

Visual inspection 67, 68

W

Warnings 7

Weight 35

Width 35

Working equipment 81

MULTIVAC branch offices

GERMANY

MULTIVAC Sepp Haggenmüller GmbH & Co. KG
Tel.: +49 83 34 601 0
Fax:+49 83 34 601 199
multivac@multivac.de
www.multivac.com

SWITZERLAND

MULTIVAC EXPORT AG
Tel.: +41 41 785 65 65
Fax:+41 41 785 65 10
meag@multivac.ch
www.multivac.com

GERMANY

MULTIVAC Marking & Inspection GmbH & Co. KG
Tel.: +49 5224 931-0
Fax:+49 5224 931-299
multivac-mi@multivac.com
www.multivac.de

GERMANY

MULTIVAC Resale & Service GmbH
Tel.: +49 2157 8197 0
Fax:+49 2157 8197 22
info@multivacresale.de
www.multivac.de

ARGENTINA

MULTIVAC Argentina S.A.
Tel.: +54 11 4723 3766
Fax:+54 11 4723 4098
info@multivac.com.ar
www.multivac.com

AUSTRALIA

MULTIVAC Australia PTY. LTD.
Tel.: +61 3 8331 2800
Fax:+61 3 8331 2810
info@multivac.com.au
www.multivac.com

BELGIUM

Multivac N.V.
Tel.: +32 15 569 50 9
Fax:+32 15 569 50 1
mub@multivac.be
www.multivac.com

BRAZIL

MULTIVAC do Brasil
Tel.: +55 19 3795-0818
Fax:
nelson.dematos@br.multivac.com
www.multivac.com

BULGARIA

MULTIVAC Bulgaria EOOD
Tel.: +359 2 988-55-00
Fax:+359 2 988-55-88
service@bg.multivac.com
www.multivac.bg

CHILE

MULTIVAC CHILE S.A.
Tel.: +56 27 996 00 0
Fax:+56 27 996 00 1
mucl@cl.multivac.com
www.multivac.com

CHINA

MULTIVAC (Shanghai) Trading Co.
Building 7, Lane 195, Qianpu Road (Shanghai)
Tel.: +86 21 3701 8118
Fax:+86 21 3766 0051
info@cn.multivac.com
www.multivac.cn

DENMARK

MULTIVAC A/S
Tel.: +45 75 853 42 2
Fax:+45 75 853 45 4
mudk@multivac.dk
www.multivac.com

ESTONIA

MULTIVAC Oy Estonia Branch
Tel.: +372 622 8258
Fax:+372 622 8259
margus.kupp@ee.multivac.com
www.multivac.com

FINLAND

MULTIVAC Oy
Tel.: +358 20 792 13 00
Fax:+358 20 792 13 71
multivac@fi.multivac.com
www.multivac.com

FRANCE

MULTIVAC FRANCE S.A.S.
Tel.: +33 16 412 13 14
Fax: +33 16 412 75 30
muf@multivac.fr
www.multivac.com

GREECE

MULTIVAC Hellas Mepe
Tel.: +30 21 066 19 621
Tel.: +30 21 066 19 622
Fax: +30 21 066 19 662
info@gr.multivac.com
www.multivac.com

GREAT BRITAIN

MULTIVAC UK Ltd.
Tel.: +44 1793 425800
Fax: +44 1793 616219
sales@multivac.co.uk
www.multivac.com

INDIA

MULTIVAC Laraon India Private Limited
Tel.: +91 12 446 10 000
Fax:
info@multivac.co.in
www.multivac.com

IRELAND

MULTIVAC Ireland Ltd.
Tel.: +353 (0) 1 4133200
Fax: +353 (0) 1 4133205

www.multivac.com

ISRAEL

MULTIVAC B.P.S. Ltd.
Tel.: +972 46 344 68 1
Fax: +972 46 344 67 8
muil@multivac.co.il
il.multivac.com

ITALY

MULTIVAC Italia Service S.R.L.
Tel.: +39 02 450 32 08
Fax: +39 02 458 63 819
muit@it.multivac.com
www.multivac.com

JAPAN

Tokyo Foods Machinery Co. Ltd.
Tel.: +81 33 663 40 06
Fax: +81 33 662 49 41
t.orimi@tokyofoods.co.jp
www.multivac.com

CANADA

MULTIVAC Canada Inc.
Tel.: +1 905 264 1170
Fax: +1 905 264 9647
info@ca.multivac.com
www.multivac.com

COLUMBIA

Corporación MULTIVAC S.A.S. Oficinas
Tel.: +57 1 547 5241
Fax: +57 1 547 4276
info@co.multivac.com
www.multivac.com

CROATIA

MULTIVAC d.o.o.
Tel.: +385 14 855 20 5
Fax: +385 14 855 20 4
multivac@zg.t-com.hr
www.multivac.com

LATVIA

MULTIVAC Oy Latvia Branch
Tel.: +371 67 623 121
Fax: +371 67 622 602
girts.lazdins@lv.multivac.com
www.multivac.com

LITHUANIA

MULTIVAC Oy filialas Bukiškės
Tel.: +370 52 105 03 6
Fax: +370 52 336 41 3
donatas.margis@multivac.com
www.multivac.com

MEXICO

MULTIVAC Mexico S.A. de C.V.
Tel.: +52 55 502 05 555
Fax: +52 55 502 05 560
contacto@multivac.com
www.multivac.com

NEW ZEALAND

MULTIVAC New Zealand Ltd.
Tel.: +64 9 238-3055
Tel.: +64 2 146-0807
Fax: +64 9 238-3054
info@multivac.co.nz
www.multivac.com

NETHERLANDS

MULTIVAC BV
Tel.: (+31) 0348 436570
Fax: (+31) 0348 436580
munl@multivac.nl
www.multivac.com

NORTH AFRICA

MULTIVAC Afrique du Nord
Tel.: +216 71 963 963
Tel.: +216 71 860 128
Fax: +216 71 860 230
munaf@multivac.fr
www.multivac.com

NORWAY

MULTIVAC AS
Tel.: +47 33 445 25 0
Fax: +47 33 445 25 1
mun@multivac.no
www.multivac.com

AUSTRIA

MULTIVAC Vertriebsgesellschaft mbH
Tel.: +43 (0)1 698 1300
Fax:+43 (0)1 698 1300-99
info@multivac.at
www.multivac.com

POLAND

MULTIVAC Sp. z o. o.
Tel.: +48 81 746 67 00
Fax:+48 81 746 67 01
mupl@multivac.pl
www.multivac.com

PORTUGAL

Multi Vacuo - Sistemas de Embalagens Lda.
Tel.: +351 21 41 95 541
Tel.: +351 93 77 74 355
Fax:+351 21 41 95 543
diogo.magalhaes@pt.multivac.com
www.multivac.com

ROMANIA

MULTIVAC Romania S.R.L
Tel.: +40 21 345 34 61
Fax:+40 21 345 34 61
adrian.dobre@multivac.ro
www.multivac.com

RUSSIA

MULTIVAC Rus / Moscow
127254 Moscow
Tel.: +7 495 604 4902
Fax:+7 495 604 4903
office@ru.multivac.com
www.multivac.com

SWEDEN

MULTIVAC Sverige
Tel.: +46 311 70 0
Fax:+46 150 30 0
mus@multivac.se
www.multivac.com

SERBIA

MULTIVAC d.o.o.
Tel.: +381 21 4721 144
Fax:+381 21 4721 146
info@multivac.rs
www.multivac.com

SINGAPORE

MULTIVAC Pte. Ltd.
Tel.: +65 6565 3919
Fax:+65 6566 9798
David.Lum@sg.multivac.com
www.multivac.com

SLOVAKIA

MULTIVAC Export AG organizačná zložka Slovakia Ges.m.b.H & Co. KG
Tel.: +421 24 446 40 70
Fax:+421 24 446 40 72
info@sk.multivac.com
www.multivac.com

SPAIN

MULTIVAC Packaging Systems España, S.L.
E - 08396 Sant Cebrià de Vallalta (Barcelona)
Tel.: +34 902 290 909
Fax:+34 937 632 517
info@es.multivac.com
www.multivac.com

SOUTH AFRICA

MULTIVAC Southern Africa PTY. (LTD.)
Tel.: +27 16 340 5800
Fax:+27 16 340 5819
alex.ferguson@multivacsa.com
www.multivac.com

SOUTH KOREA

MULTIVAC KOREA CO., LTD
Tel.: +82-70-4895-4041
Fax:+82-70-8244-4050
info@kr.multivac.com
www.multivac.com

CZECH REPUBLIC

MULTIVAC Packing Machines, Ceska Republika S.R.O.
Tel.: +420 26 126 05 16
Fax:+420 26 126 05 18
mucz@cz.multivac.com
www.multivac.com

TURKEY

MULTIVAC Ambalaj Makineleri San. ve Tic. A.Ş.
Tel.: +90 216 526 00 33
Fax:+90 216 526 03 83
info@tr.multivac.com
www.multivac.com

UKRAINE

MULTIVAC Ukraine LLC
Tel.: +380 44 499 90 70
Fax:+380 44 499 90 67
office@ua.multivac.com
www.multivac.com

HUNGARY

MULTIVAC Hungária Kft.
Tel.: +36 23 500 28 7
Fax: +36 23 500 28 8
info@hu.multivac.com
www.multivac.com

USA

MULTIVAC, Inc.
Tel.: +800 877 5200
Tel.: +1 816 891 0555
Fax: +800 347 6164
Fax: +1 816 891 0622
muinc@multivac.com
www.multivac.com

UNITED ARAB EMIRATES

MULTIVAC Middle East (FZE),
Amir Sotoudeh
Tel.: +971 4 299 1980
Fax: +971 4 299 1981
amir.sotoudeh@ae.multivac.com
www.multivac.com