

Owner's Manual

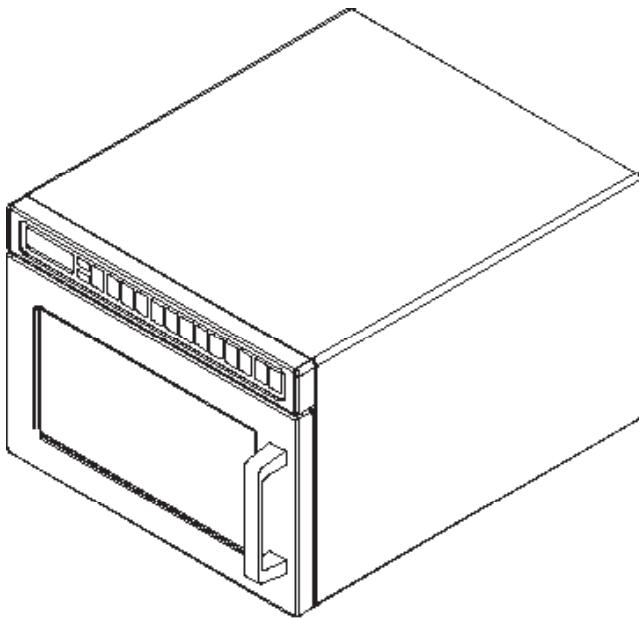

Heavy Duty Commercial Compact [0.6 Cubic Foot] Microwave Oven

Keep these instructions for future reference.
If the oven changes ownership, this manual must
accompany oven.

Contents	
Model Identification	2
IMPORTANT SAFETY INSTRUCTIONS ...	3
PRECAUTIONS TO AVOID POSSIBLE EXPOSURE TO EXCESSIVE MICROWAVE ENERGY	4
Grounding/Earthing Instructions.....	5
Installation	6
Display and Features Style 1	7
Operation Style 1	9
Programming Style 1.....	10
Options Style 1.....	11
Display and Features Style 2	12
Operation Style 2	13
Programming Style 2.....	15
Options Style 2.....	16
Care and Cleaning	17
Before Calling for Service	19

Model Identification

When contacting ACP, provide product information.
Product information is located on oven serial plate.
Record the following information:

Model Number: _____
Manufacturing Number: _____
Serial or S/N Number: _____
Date of purchase: _____
Dealer's name and address: _____

Any questions or to locate an authorized service agent contact ACP, Inc. ComServ Customer Service at: Phone 866.426.2621 / 319.368.8195 or email: commercialservice@acpsolutions.com. Warranty service must be performed by an authorized servicer. ACP also recommends contacting an authorized servicer if service is required after warranty expires.

Keep a copy of sales receipt for future reference or in case warranty service is required.

IMPORTANT SAFETY INSTRUCTIONS



This is the safety alert symbol. It is used to alert you to potential personal injury hazards. Obey all safety messages that follow this symbol to avoid possible injury or death.



WARNING

When using electrical oven, basic safety precautions should be followed to reduce the risk of burns, electric shock, fire, or injury to persons or exposure to excessive microwave energy.

1. READ all instructions before using oven.
2. READ AND FOLLOW the specific "PRECAUTIONS TO AVOID POSSIBLE EXPOSURE TO EXCESSIVE MICROWAVE ENERGY" on page 4.
3. This oven MUST BE GROUNDED. Connect only to properly GROUNDED outlet. See "GROUNDING INSTRUCTIONS" on page 7.
4. Install or locate this oven ONLY in accordance with the installation instructions in this manual.
5. Some products such as whole eggs and sealed containers – for example, closed glass jars – may explode and SHOULD NOT be HEATED in this oven.
6. Use this oven ONLY for its intended use as described in this manual. Do not use corrosive chemicals or vapors in this oven. This type of oven is specifically designed to heat or cook. It is not designed for industrial or laboratory use.
7. As with any oven, CLOSE SUPERVISION is necessary when used by CHILDREN.
8. If smoke is observed, switch off or unplug the appliance and keep the door closed in order to stifle any flames.
9. DO NOT operate this oven if it has a damaged cord or plug, if it is not working properly, or if it has been damaged or dropped.
10. This oven, including power cord, must be serviced ONLY by qualified service personnel. Special tools are required to service oven. Contact nearest authorized service facility for examination, repair, or adjustment.
11. DO NOT cover or block filter or other openings on oven.
12. DO NOT store this oven outdoors. DO NOT use this product near water – for example, near a kitchen sink, in a wet basement, or near a swimming pool, and the like.
13. DO NOT immerse cord or plug in water.
14. Keep cord AWAY from HEATED surfaces.
15. DO NOT let cord hang over edge of table or counter.
16. See door cleaning instructions in "Care and Cleaning" section of manual on page 17.
17. For commercial use only.



WARNING

To reduce the risk of fire in the oven cavity:

- a. DO NOT overcook food. Carefully attend oven if paper, plastic, or other combustible materials are placed inside the oven to facilitate cooking.
- b. Remove wire twist-ties from paper or plastic bags before placing bag in oven.
- c. KEEP oven DOOR CLOSED, turn oven off, and disconnect the power cord, or shut off power at the fuse or circuit breaker panel, if materials inside the oven should ignite. Fire may spread if door is opened.
- d. DO NOT use the cavity for storage. DO NOT leave paper products, cooking utensils, or food in the cavity when not in use.

SAVE THESE INSTRUCTIONS

IMPORTANT SAFETY INSTRUCTIONS



CAUTION

To avoid personal injury or property damage, observe the following:

1. Briskly stir or pour liquids before cooking with microwave energy to prevent spontaneous boiling or eruption. Do not overheat. If air is not mixed into a liquid, liquid can erupt in oven or after removal from oven.
2. Do not deep fat fry in oven. Fat could overheat and be hazardous to handle.
3. Do not cook or reheat eggs in shell or with an unbroken yolk using microwave energy. Pressure may build up and erupt. Pierce yolk with fork or knife before cooking.
4. Pierce skin of potatoes, tomatoes, and similar foods before cooking with microwave energy. When skin is pierced, steam escapes evenly.
5. Do not operate oven without load or food in oven cavity.
6. Use only popcorn in packages designed and labeled for microwave use. Popping time varies depending on oven wattage. Do not continue to heat after popping has stopped. Popcorn will scorch or burn. Do not leave oven unattended.
7. Do not use regular cooking thermometers in oven. Most cooking thermometers contain mercury and may cause an electrical arc, malfunction, or damage to oven.
8. Do not heat baby bottles in oven.
9. Do not use metal utensils in oven.
10. Never use paper, plastic, or other combustible materials that are not intended for cooking.
11. When cooking with paper, plastic, or other combustible materials, follow manufacturer's recommendations on product use.
12. Do not use paper towels which contain nylon or other synthetic fibers. Heated synthetics could melt and cause paper to ignite.
13. Do not heat sealed containers or plastic bags in oven. Food or liquid could expand quickly and cause container or bag to break. Pierce or open container or bag before cooking.
14. To avoid pacemaker malfunction, consult physician or pacemaker manufacture about effects of microwave energy on pacemaker.

PRECAUTIONS TO AVOID POSSIBLE EXPOSURE TO EXCESSIVE MICROWAVE ENERGY

- a. DO NOT attempt to operate this oven with door open since open-door operation can result in harmful exposure to microwave energy. It is important not to defeat or tamper with safety interlocks.
- b. DO NOT place any object between oven front face and door or allow soil or cleaner residue to accumulate on sealing surfaces.
- c. DO NOT operate oven if it is damaged. It is particularly important that oven door close properly and that there is no damage to: (1) door (bent), (2) hinges and latches (broken or loosened), (3) door seals and sealing surfaces.
- d. Oven should NOT be adjusted or repaired by anyone except properly qualified service personnel.

SAVE THESE INSTRUCTIONS

Grounding Instructions



WARNING

To avoid risk of electrical shock or death, this oven must be grounded.



WARNING

To avoid risk of electrical shock or death, do not alter the plug.

This oven **MUST** be grounded. In the event of an electrical short circuit, grounding reduces the risk of electric shock by providing an escape wire for the electric current. This oven is equipped with a cord having a grounding wire with a grounding plug. The plug must be plugged into an outlet that is properly installed and grounded.

Consult a qualified electrician or servicer if grounding instructions are not completely understood, or if doubt exists as to whether the oven is properly grounded.

Do not use an extension cord. If the product power cord is too short, have a qualified electrician install a three-slot receptacle. This oven should be plugged into a separate circuit with the electrical rating as shown on the oven's serial plate / rating label. When a microwave oven is on a circuit with other equipment, an increase in cooking times may be required and fuses can be blown.

Earthing Instructions

Oven MUST be earthed. Earthing reduces risk of electric shock by providing an escape wire for the electric current, if an electrical short occurs. This oven is equipped with a cord having a earth wire with a earthing plug. The plug must be plugged into an outlet that is properly installed and earthed.

Consult a qualified electrician or servicer if earthing instructions are not completely understood, or if doubt exists as to whether the oven is properly earthed.

Do not use an extension cord.

If the product power cord is too short, have a qualified electrician install a new receptacle close enough to the oven to plug the oven in. This oven should be plugged into a separate circuit with the electrical rating as provided in product specifications (available on www.acpsolutions.com). When a microwave oven is on a circuit with other equipment, an increase in cooking times may be required and fuses can be blown.

External Equipotential Earthing Terminal

(export only)

Equipment has secondary earthing terminal. Terminal provides external earthing connection used in addition to earthing prong on plug. Located on outside of oven back, terminal is marked with symbol shown below.



Installation

Unpacking Oven

- Inspect oven for damage such as dents in door or dents inside oven cavity.
- Report any dents or breakage to source of purchase immediately. Do not attempt to use oven if damaged.
- Remove all materials from oven interior.
- If oven has been stored in extremely cold area, wait a few hours before connecting power.

Radio Interference

Microwave operation may cause interference to radio, television. Reduce or eliminate interference by doing the following:

- Clean door and sealing surfaces of oven according to instructions in “Care and Cleaning” section.

⚠ WARNING

Excessive Weight Hazard

Use two or more people to move and install oven.

Failure to do so can result in back or other injury.

Oven Placement

- Do not install oven next to or above source of heat, such as pizza oven or deep fat fryer. This could cause microwave oven to operate improperly and could shorten life of electrical parts.
- Do not block or obstruct oven filter. Allow access for cleaning.
- Install oven on level countertop surface.

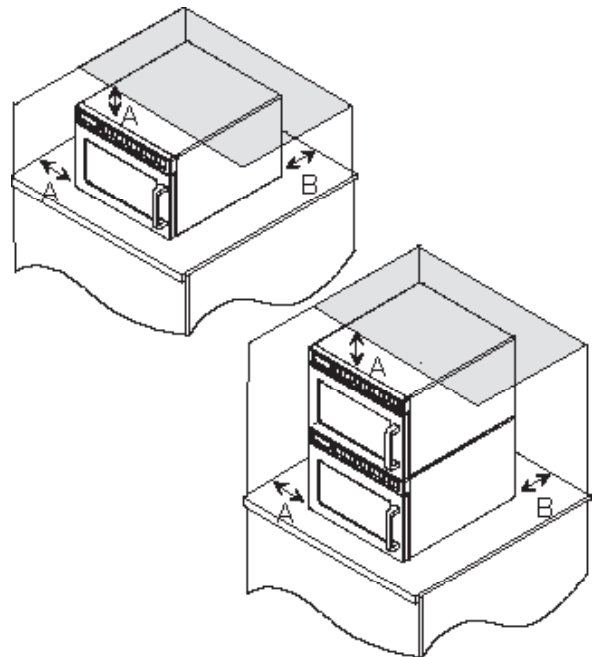

- A—Allow at least 7" (17.8 cm) of clearance around top and sides of oven. Proper air flow around oven cools electrical components. With restricted air flow, oven may not operate properly and life of electrical parts is reduced.
- B—Allow at least 2 9/16" (6.5 cm) between air discharge on back of oven and back wall.

Oven Clearances

Display and Features

NOTE: There are two styles of controls shown Style 1 and Style 2 choose the control that matches unit

STYLE 1



TIME ENTRY pad is used to enter cooking time for either manual entry or programming. Cooking time ranges from 1 second (00:01) to a total of 60 minutes (60:00) over four stages. If more than 60 minutes of total microwave cooking time is required, open door and inspect food before beginning new cooking cycle.



Numbered pads begin cooking programs or enter times and power levels for “Manual Time Entry” cooking.



POWER LEVEL pad is used to set microwave power level. When cooking, the power level can be decreased for foods that require slower more even cooking. Microwave power levels range from 0% to 100% in 10% increments. If cooking time is set and START pad pressed, oven cooks at 100% power. When programming, to reset power level to 100%, press POWER LEVEL pad.



START pad begins Manual Time Entry cooking or restarts an interrupted cooking cycle. When programming, use to save time and power level, and to advance to next user option.



STOP/ RESET pad exits programming mode and stop cooking during cooking cycle.



Display (some models)
Some items in display can be seen but will not glow.

Stages

This oven can be programmed to run 4 cooking sequences consecutively. Each sequence is called a stage. For example, the first cycle could be programmed to defrost at 60% power, the second to defrost at 30% power, the third to heat at 100% power, and the fourth to hold warm at 10% power. Total time for all cooking stages counts down.

User Options

User Options allow the user to program the oven to perform in a way convenient to the user. The beeps, maximum cooking time, and number of pre-programmed cooking sequences can be changed.

X2 Pad

The X2 Pad increases a preset cooking time by a percentage of the original cooking time. The user specifies the percentage and it can be changed for individual cooking sequences. This feature is very useful for cooking multiple servings of foods such as potatoes or slices of pizza.

Display and Features

STYLE 1

Cooking Methods

MEMORY PADS

This oven can store either 10 or 100 cooking programs in memory.

Single Pad Cooking

From the factory, it is programmed to store 10 cooking programs. Each pad begins a cooking program.



Double Pad Cooking

The oven control can be changed to store up to 100 cooking programs. To set the control to 100 cooking programs, see the "User's Options" section of this manual. To heat when the oven is set for 100 programs, press 2 memory pads. For example, to start the first program, press pad 0, then pad 1. To use the second program, press pad 0, then pad 2. After the pads are pressed, the oven starts automatically and time counts down.



MANUAL TIME ENTRY

Manual Time Entry feature allows the operator to heat without changing the preprogrammed pads. Time must be entered and power can be set before cooking. START pad must be pressed to begin cooking.



Cooking Displays



READY shows when oven control will accept entries.



14:37 shows cooking time. When more than one cooking stage is programmed, total time for all stages

displays. COOKING Shows when microwave energy is generated. % MW POWER shows when oven is operating. 50 indicates the microwave power level used. If number does not show, oven is cooking at 100% power.

Programming Displays



This display indicates oven is in programming mode and ready to program a numbered pad(s).



This display indicates oven is set to double pad entry and 2 pads must be pressed to enter a program. See "Programming" section of manual for programming procedure or "User Options" to change from single or double pad entry.



This display shows briefly when programming more than one stage. It indicates programming mode for pad 02. Press Time Entry to choose stage to be programmed.





This display indicates programming user options mode. See "User Options" section of manual for programming procedure.

Operation

STYLE 1

Interrupting Operation

Open oven door or press *STOP/RESET* pad  to interrupt operation. Display continues to show

countdown time. Close door and press *START*  pad to resume oven operation.

Canceling Mistakes

If oven is not cooking, press *STOP/RESET*  pad to clear display. If oven is cooking, press *STOP/RESET* pad once to stop oven, then again to clear display. If oven door is open and time shows in display, close oven door and press *STOP/RESET* pad to clear display.

Operating Preprogrammed Pads

From the factory, this oven can store up to 10 preprogrammed cooking sequences in memory. To heat using a preprogrammed sequence, press a numbered pad. Oven starts to heat automatically. Example: Heat using the third cooking sequence.

3

1. Open oven door, place food in oven, and close oven door.
 - Display shows "READY".
 - If pad is not pressed in 60 seconds, open and close oven door again.
2. Press 3 pad.
 - Oven operates and time counts down.
 - Display shows cooking time, "STAGE 1", "COOKING". Display shows "COOKING" only when microwave energy is present.
 - If power level other than 100 percent power was programmed, display shows "STAGE 1", "COOKING" and "% MW POWER".
 - If additional cooking time is required, press preprogrammed pads before or after cooking cycle ends.
3. Oven stops cooking and oven signal sounds when cooking timing elapses.

Preprogrammed Times and Cook Level

All preprogrammed pads arrive set at full power.

Double Pad Programs

The oven control can be changed to store up to 100 cooking programs. See the "User's Options" section of this manual to change oven control.





To start a double pad cooking program, press 2 memory pads. For example, press pad 0 and pad 3 to start a cooking program.



Manual Time Entry

Manual Time Entry feature allows the operator to enter time and power levels, and heat without changing the preprogrammed pads. Example: Heat for 30 seconds at 80% power.







1. Open oven door, place food in oven, and close door.
 - Display shows "READY". Fan and light operate.
 - If pad is not pressed in 60 seconds, open and close oven door again.
2. Press TIME ENTRY  pad.
 - Display shows "00:00" and "READY".
3. Press 3 and 0 pad to enter cooking time.
4. Press POWER LEVEL  pad to change power level.
 - Display shows "% MW POWER" and current power level if other than 100 percent power.
5. Press 8 pad to enter desired power level.
6. Press START  pad.
 - Oven operates and time counts down.
 - Display shows cooking time, "COOKING", "% MW POWER".
 - Display shows "COOKING" only when microwave energy is present.
 - If power level other than 100 percent power was programmed, display shows "COOKING" and "% MW POWER". Display counts down cooking time.
7. Oven stops cooking and oven signal sounds when cooking timing elapses and display shows "DONE".

Programming

STYLE 1

Memory Pads

From the factory, this oven can store up to 10 cooking programs. Follow instructions below to program cooking times and power levels for customized cooking. Example: Program third cooking sequence to heat for 30 seconds at 80% power.

1. Open oven door.
 - Display shows “DOOR”.
 - If door is closed or STOP/RESET  pad is pressed before finishing programming sequence, oven exits programming mode.
2. Press and hold pad 1 for approximately 5 seconds.
 - After 5 seconds, signal sounds. Display shows “PROGRAM”.
3. Press 3 pad to select memory pad.
 - Display shows cooking time, “STAGE 1” and power level if other than 100 percent power.
4. Press 3 and 0 pad to enter desired cooking time.
5. Press POWER LEVEL  pad to change power level.
 - Display shows cooking time and current power level if other than 100 percent power.
6. Press 8 pad to enter desired power level.
Note: Press POWER LEVEL  twice to reset to 100% power.
7. Press START  pad to save new cooking time and power level in oven memory.
 - Display shows “PROGRAM”.
 - Repeat step 3–8 to program additional pads.
8. Press STOP/RESET  pad or close oven door
 to exit programming mode.





Double Pad Programs

The oven control can be changed to store up to 100 cooking programs. See the “User’s Options” section of this manual to change oven control.

To create a double pad program, follow the instructions above except for a change to step #3. When entering the cooking program number, press 2 memory pads. For example, press pads 0 and pad 3 to create a new cooking program.

Multiple Cooking Stages

Follow instructions below to program oven to perform four consecutive cooking cycles without interruption. Example: Program third cooking sequence to heat for 30 seconds at 80% power, 40 seconds at 50% power, and 10 seconds at 100% power.

1. Open oven door.
 - Display shows “READY”.
 - If door is closed or STOP/RESET  pad is pressed before finishing programming sequence, oven exits programming mode.
2. Press pad 1 for approximately 5 seconds.
 - After 5 seconds, signal sounds. Display shows “PROGRAM”.
3. Press 3 pad to select memory pad.
 - Display shows “P03” briefly then cooking time, “STAGE 1” and power level if other than 100 percent power.
4. Press 3 and 0 to enter desired cooking time.
5. Press POWER LEVEL  pad to change power level.
 - Display shows “% MW POWER” and current power level if other than 100 percent power.
6. Press 8 pad to enter desired power level.
7. Press TIME ENTRY  pad.
 - Display shows cooking time, and “STAGE 2” indicating programming stage 2 and power level for stage shown in display.
 - Repeat steps 5–8 to create additional stages.
8. Press START  pad to save new cooking time and power level in oven memory.
9. Press STOP/RESET  pad or close oven door to exit programming mode.

Options

STYLE 1

User Options

Follow the instructions below to customized the microwave oven's operation. End-of-cycle signal, maximum cooking time and other options can be changed to meeting your cooking needs. Example: Change setting to single digit pad operation.

1. Open oven door.

- If door is closed or STOP/ RESET  pad is pressed before finishing programming sequence, oven exits programming mode.

2. Press and hold pad 2 for approximately 5 seconds.

- After 5 seconds, signal sounds. Display shows "OPTIONS".

3. Press 9 pad.

- See table for options.
- Displays shows "OP:90".
- "OP" represents optional program mode, first number represents option number and second number represents functions currently selected for option.

4. Press 9 pad repeatedly to change setting.

5. Press START  pad to save changes.

- Repeat steps 3-5 to change additional options.
- Changes appear after door is closed or STOP/ RESET is pressed.

6. Press STOP/RESET  pad or close oven door to exit programming mode.

Numbered Pads	Display	Options (Factory Settings in Bold)
1 End of Cycle Beep	OP:10 OP:11 OP:12	3 second continuous beep Continuous beep until door is opened 5 beeps bursts until door is opened
2 Speaker Volume	OP:20 OP:21 OP:22 OP:23	Eliminates beep Sets volume to low Sets volume to medium Sets volume to high
3 Key Beep	OP:30 OP:31	Prevents beep when pad is pressed. Allows beep when pad is pressed.
4 Keyboard Enable Window	OP:40 OP:41 OP:42 OP:43	15 seconds after oven door is opened, keyboard disabled 30 seconds after oven door is opened, keyboard disabled 1 minute after oven door is opened, keyboard disabled 2 minutes after oven door is opened, keyboard disabled
5 Add Time during Heating	OP:50 OP:51	Prevents adding heating time while oven is heating. Allows adding heating time while oven is heating when a memory pad is pressed.
6 Reset Door Open	OP:60 OP:61	Cancels heating time count down after door is opened during cycle. Allows oven to resume heating time countdown after door is opened during cycle.
7 Maximum Heating Time	OP:70 OP:71	Allows 60 minutes of heating time. Allows 10 minutes of heating time.
8 Manual Operation	OP:80 OP:81	Allows use of preprogrammed pads only. Allows use of manual time entry and preprogrammed pads.
9 Double Digit Operation	OP:90 OP:91	Allows 10 (0-9) preprogrammed pads. Allows 100 (00-99) preprogrammed pads.
0 Clean Filter Message	OP:00 OP:01 OP:02 OP:03	Do not display message. Display message for 24 hours every 7 days. Display message for 24 hours every 30 days. Display message for 24 hours every 90 days.

Display and Features

STYLE 2



Start Pad

The start pad is used to begin a manual time entry cooking cycle. It is also used to save any changes to programming sequences or user options.



STOP/RESET pad

The STOP/RESET pad stops a cooking sequence in progress, clears out any remaining time, and also ends a programming or user option cycle. When the STOP/RESET pad is used to end a programming or option change, the changes are discarded.



Single Pad Programming

This feature enables each numbered pad to be programmed for a specific use, such as cooking a certain number of potatoes or defrosting and then cooking vegetables or other frozen foods. To use this feature, simply program the pad to the desired length of time and power level. To use this feature, press the pad once and the microwave will begin cooking.



Double Pad Programming

This feature enables 100 programmed entries to be made. Each entry will be assigned a double digit number, for example 01, 05, or 20. When using the double pad programming, two pads must be pressed to start the cooking cycle.



Manual Time Entry

In addition to programmable pads, this microwave also accepts specific time entry by using the TIME ENTRY pad. Using manual time entry does not affect the programmed buttons.



X2 Pad

The X2 Pad increases a preset cooking time by a percentage of the original cooking time. The user specifies the percentage and it can be changed for individual cooking sequences. This feature is very useful for cooking multiple servings of foods such as potatoes or slices of pizza.



Stage Cooking

Stage cooking is a cooking sequence with specific power stage changes. The user can program up to four different power level changes and the specific amount of cooking time at each power level. Each power level/cooking time combination is known as a stage. Up to four stages can be programmed.



User Options

This microwave can be set for specific user preferences. Options such as beep volume, maximum cooking time, and the number of programmable pads can be changed. To change different options, see *User Options* in this manual.

Operation

STYLE 2

Cooking Display

DISPLAYS	DESCRIPTION
READY	READY displays when oven control will accept entries.
00:00	Displays cooking time. If stage cooking is programmed, total cooking time is displayed.
COOK LEVEL	COOK LEVEL displays while oven is operating. The cooking level is displayed above as a number 1 through 9. If no number is displayed, the oven is cooking at full power.
POWER	POWER is displayed while the oven is generating microwave energy during a cooking cycle.

? There are words in the display that never actually display. The display is used for many different models of microwaves. Depending on the model, certain words or symbols may never be highlighted or become visible.

Programming Display

DISPLAYS	DESCRIPTION
P:0	Displays when oven is in programming mode for single pad memory only.
P:	Displays when oven is in programming mode for double pad memory.
OP: --	Displays when oven is in user option mode. User options can then be set or specified.
CF:	Displays with a numerical cooking factor when the X2 pad is pressed.
P:-- ¹	Displays briefly when programming a specific cooking stage. Number (1 through 4) indicates the stage that is being programmed.

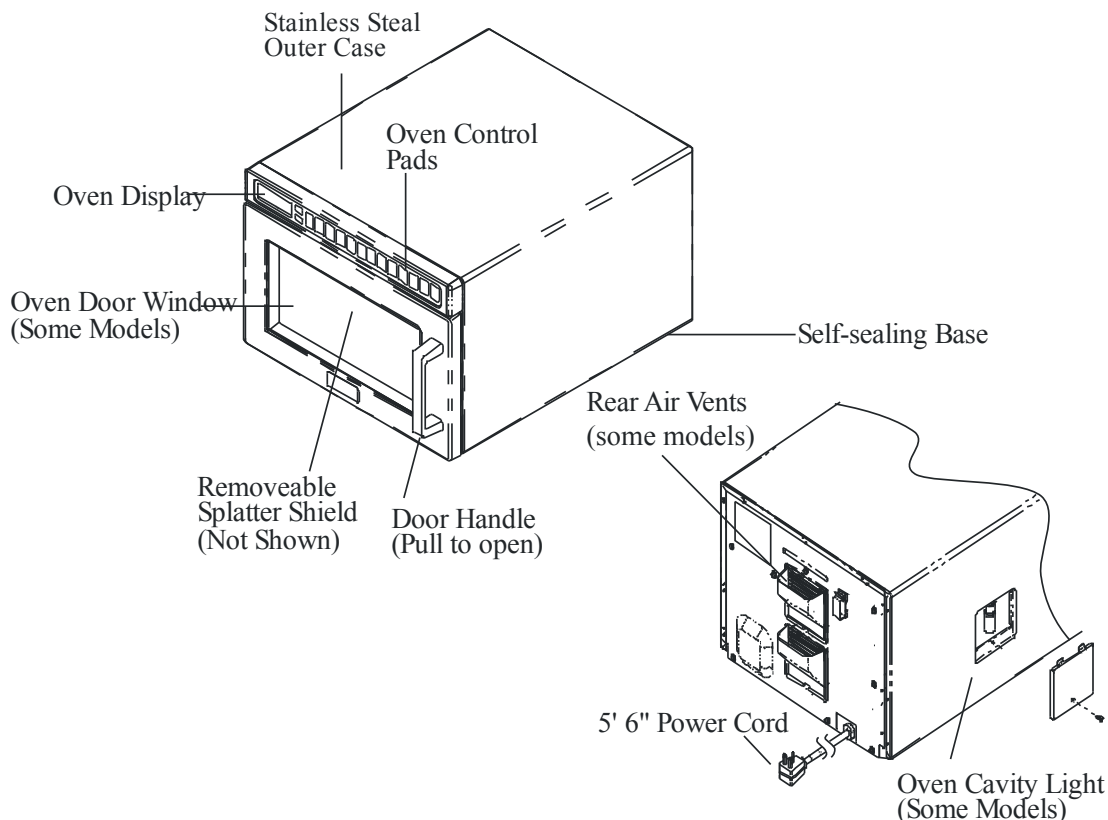

Operation

STYLE 2



Interrupting Operation

Open oven door or press STOP/RESET pad to interrupt operation. Display continues to show countdown time. Close door and press START pad to resume oven operation.

Canceling Mistakes

- If oven is not cooking, press STOP/RESET pad to clear display.
- If oven is cooking, press STOP/RESET pad once to stop oven, then again to clear display.
- If oven door is open and time shows in display, close oven door and press STOP/RESET pad to clear display.



X2 Pad

To increase cooking time when cooking more than one serving.

1. Open oven door and place food in oven. Close door.
 - **READY** displays. Fan and light will turn on.
2. Press X2 pad.
 - Amount of time added is a percentage of the original preprogrammed cooking time.
 - The percentage can be changed. See *Programming* section in this manual.
3. Press desired preprogrammed pad.
4. Oven begins cooking. Displayed cooking time is the total of original cooking time and added X2 time.

Manual Time Entry

To cook food using a specific entered time and power level.

1. Open oven door and place food in oven. Close door.
 - **READY** displays. Fan and light will turn on.
2. Press TIME ENTRY pad.
 - **READY** and 00:00 display.
 - If pad does not work, open and close oven door and try again.
3. Enter cooking time by using the numbered pads.
4. Press POWER LEVEL pad to change power level.
 - **COOK LEVEL** displays with the power setting.
 - If a number is not displayed with COOK LEVEL the microwave is set to full power.
 - Press a number pad to adjust power level to desired setting.
5. Press TIME ENTRY pad.
 - Display changes to cook time and power level for the next stage.
6. Enter cook time and power level as in steps 3 and 4.
 - To add another cooking stage press TIME ENTRY pad again.
 - Up to four different stages can be programmed.
7. Press START pad.
 - Oven operates and time counts down.
 - **POWER, COOK LEVEL** and cooking time display.



Preprogrammed Pads

To cook food using pads preprogrammed with cooking sequences.

1. Open oven door and place food in oven. Close door.
 - **READY** displays. Fan and light will turn on.
2. Press desired pad.
 - For single pad entry, press only one pad.
 - For double pad entry, press the two pads, in order, of the double digit number for the desired cooking sequence.
 - To change single or double pad entry option see *User Options* section in this manual.
3. Oven begins to cook.
 - **POWER, COOK LEVEL** and total cooking time display.
 - For additional cooking time, press preprogrammed pad again to begin cooking sequence again.



Factory Settings

Pad	Time
1	10 sec.
2	20 sec.
3	30 sec.
4	45 sec.
5	1 min.

Pad	Time
6	1:30 min.
7	2 min.
8	3 min.
9	4 min.
0	5 min.

Programming

STYLE 2

Programming Pads

Oven is shipped from the factory for single pad programming. To change the oven default to allow double pad programming, see *User Options*.

To change the amount of time or the power level for a preset pad:

1. Open oven door.
 - **READY** displays.
 - If door is closed or RESET pad is pressed before programming is complete, changes are discarded and microwave exits programming mode.
2. Press and hold pad 1 for approximately 5 seconds.
 - This begins programming mode.
 - Microwave will beep and P:0 displays. Oven is in programming mode.
3. Press pad to be reprogrammed.
 - Press two digits if reprogramming a double pad program.
 - **COOK LEVEL** and cooking time display.
 - A number displays with **COOK LEVEL** if it is less than full power.
4. Enter cooking time by using the number pads.
5. Press POWER LEVEL pad to change power level if desired.
 - Use the number pads to change power level to a lower power setting.
6. Press START pad to set new programming to the pad.
 - If START is not pressed, changes will not be saved.
 - P:0 displays
7. Press STOP/RESET pad or close oven door to exit programming mode.



X2 Programming

This feature allows a preset percentage of original cook time, called a cooking factor, to be added to a cook sequence.

To change the cooking factor:

1. Open oven door.
2. Press and hold pad 1 for approximately 5 seconds.
3. Press pad to be reprogrammed.
4. Press the X2 pad.
5. Press a numbered pad to change the cooking factor.
 - Pad 5 would change the cooking factor to 50%.
 - Pad 3 would change the cooking factor to 30%.
6. Press START pad to save changes.

Programming Multiple Stages

Stage cooking allows consecutive cooking cycles without interruption.

Up to four different cooking cycles can be programmed into a memory pad. To use stage cooking:

1. Follow steps 1 through 5 above.
6. Press TIME ENTRY pad.
 - Display briefly shows the pad number that is being programmed and the stage number to the upper right.
 - Display changes to cook time and power level for the next stage.
7. Enter cook time and power level as in steps 4 and 5.
 - To enter another cooking stage for that pad, press TIME ENTRY pad again.
 - Up to four different stages can be programmed.
8. Press START pad to set new programming changes to the pad.



Options

STYLE 2

Didn't like an option?

Factory settings are marked in bold. To change the oven back to the factory setting, simply select the option that is marked in bold.



My changes weren't saved.

In order for any changes to be saved, the START pad must be pressed after selecting an option. Shutting the oven door or pressing the STOP/RESET pad will not

Changing user options

Options such as single or double pad programming, beep volume, and maximum cooking time can be changed to suit individual preferences. To change options:

1. Open oven door.
 - If door is closed or RESET pad is pressed before programming is complete, changes are discarded and microwave exits programming mode.
2. Press and hold pad 2 for approximately 5 seconds.
 - This begins options mode.
 - Microwave will beep and OP: displays. Microwave is now in programming mode.
3. Press number pad that controls option to be changed.
 - See table below for options.
 - Current option will display.
4. Press number pad again to change the option.
 - Each time pad is pressed, option will change.
 - Match code displayed with code for desired option.
5. Press START pad to save changes.
 - To change additional options, repeat steps 3 and 4.
 - Changes appear after door is closed or STOP/RESET pad is pressed.



Numbered Pads	Display	Options (Factory Settings in Bold)
1 End of Cycle Beep	OP:10 OP:11 OP:12	3 second continuous beep Continuous beep until door is opened 5 beeps bursts until door is opened
2 Speaker Volume	OP:20 OP:21 OP:22 OP:23	Eliminates beep Sets volume to low Sets volume to medium Sets volume to high
3 Key Beep	OP:30 OP:31	Prevents beep when pad is pressed. Allows beep when pad is pressed.
4 Keyboard Enable Window	OP:40 OP:41 OP:42 OP:43	15 seconds after oven door is opened, keyboard disabled 30 seconds after oven door is opened, keyboard disabled 1 minute after oven door is opened, keyboard disabled 2 minutes after oven door is opened, keyboard disabled
5 Add Time during Heating	OP:50 OP:51	Prevents adding heating time while oven is heating. Allows adding heating time while oven is heating when a memory pad is pressed.
6 Reset Door Open	OP:60 OP:61	Cancels heating time count down after door is opened during cycle. Allows oven to resume heating time countdown after door is opened during cycle.
7 Maximum Heating Time	OP:70 OP:71	Allows 60 minutes of heating time. Allows 10 minutes of heating time.
8 Manual Operation	OP:80 OP:81	Allows use of preprogrammed pads only. Allows use of manual time entry and preprogrammed pads.
9 Double Digit Operation	OP:90 OP:91	Allows 10 (0-9) preprogrammed pads. Allows 100 (00-99) preprogrammed pads.
0 Clean Filter Message	OP:00 OP:01 OP:02 OP:03	Do not display message. Display message for 24 hours every 7 days. Display message for 24 hours every 30 days. Display message for 24 hours every 90 days.

Care and Cleaning

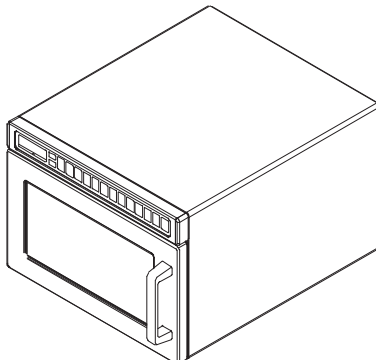
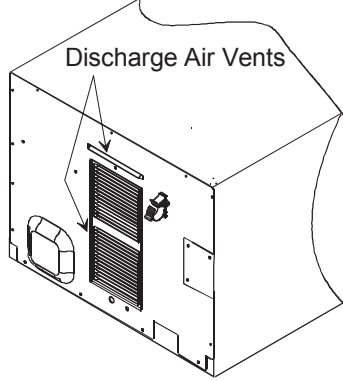

CAUTION

To avoid electrical shock which can cause personal injury, unplug power cord or open circuit breaker to oven before cleaning or removing light bulb.

Part	Description
<p data-bbox="162 441 609 483">Interior, Exterior, and Door</p> 	<p data-bbox="609 441 1505 567">Clean microwave oven with mild detergent in warm water using soft sponge or cloth. Wring sponge or cloth to remove excess water before wiping equipment. If desired, boil a cup of water in microwave oven to loosen soil before cleaning.</p> <p data-bbox="609 609 1505 651">Important:</p> <ul data-bbox="609 651 1505 798" style="list-style-type: none"> • Do not use abrasive cleansers or cleaners containing ammonia. These could damage finish. • Never pour water into microwave oven bottom. • Do not use water pressure type cleaning systems.
<p data-bbox="162 892 609 934">Discharge Air Vents</p> 	<p data-bbox="609 892 1505 987">Check monthly for a buildup of cooking vapors along intake and discharge louvers on bottom and back of oven. Clean air vents with damp cloth to ensure proper airflow. Dry thoroughly.</p>
<p data-bbox="162 1354 609 1396">Control Panel</p> 	<p data-bbox="609 1354 1505 1428">Open oven door to deactivate oven timer. Clean with mild detergent in warm water using soft sponge or cloth.</p>

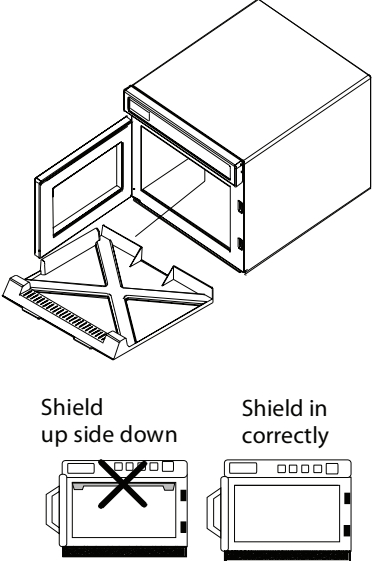
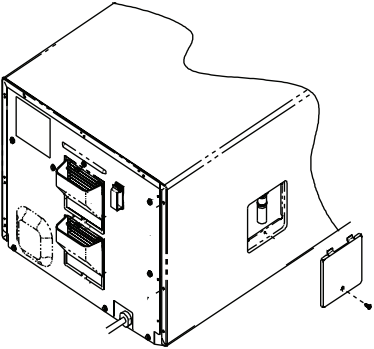
Part	Description
<p data-bbox="110 247 293 275">Air Intake Filter</p>	<p data-bbox="573 247 1442 338">Filter is located below oven door. Clean air intake filter weekly for proper airflow. Wash filter in hot water and mild detergent. Do not use oven without filter in place. Remove filter to clean.</p> <p data-bbox="573 359 699 386">Important</p> <p data-bbox="573 407 1295 434">To avoid overheating and oven damage, clean air filter regularly.</p> <ol data-bbox="573 455 1409 554" style="list-style-type: none"> <li data-bbox="573 455 1409 483">1. Grasp filter tab and pull forward. Filter will release from retaining clips. <li data-bbox="573 501 1409 554">2. To reinstall, place bottom of filter in clips and push top of filter into position.
<p data-bbox="115 583 298 611">Splatter Shields</p>  <p data-bbox="172 1016 310 1066">Shield up side down</p> <p data-bbox="370 1016 461 1066">Shield in correctly</p>	<p data-bbox="573 583 1414 674">Splatter shield keeps top of microwave oven cavity and antenna from becoming soiled. Clean soil from shield with damp cloth or clean with mild detergent and water. Remove splatter shield for easy cleaning.</p> <p data-bbox="573 695 899 722">Removing Splatter Shield</p> <ol data-bbox="573 743 1414 1157" style="list-style-type: none"> <li data-bbox="573 743 1414 800">1. Unplug oven before removing splatter shield to stop antenna from rotating. <li data-bbox="573 821 1414 1031">2. Place fingers behind shield, pull forward, and down. <ul data-bbox="618 863 1414 1031" style="list-style-type: none"> <li data-bbox="618 863 1414 919">• When removing and replacing splatter shield, be careful not to bend antenna. <li data-bbox="618 940 1414 1031">• If a gap for fingers behind splatter shield does not exist, push up on splatter shield front. Splatter shield may not be installed fully and cannot be removed until splatter shield front is properly installed. <li data-bbox="573 1052 1414 1108">3. Reinstall splatter shield by placing front tabs over lip at top of oven cavity front. Lift back of shield until shield snaps into place. <li data-bbox="573 1129 1414 1157">4. Reconnect power to oven.
<p data-bbox="110 1207 407 1234">Changing Oven Light Bulb</p> 	<p data-bbox="597 1228 724 1255">Important</p> <p data-bbox="597 1266 1349 1323">To avoid burns and cuts, wear gloves to protect hands should bulb break. If hot, allow bulb to cool.</p> <p data-bbox="573 1388 740 1415">Tools and Bulb</p> <ul data-bbox="573 1425 1029 1482" style="list-style-type: none"> <li data-bbox="573 1425 792 1453">• Protective gloves <li data-bbox="573 1453 1029 1482">• Standard screwdriver or ¼-inch socket <ol data-bbox="573 1545 1386 1698" style="list-style-type: none"> <li data-bbox="573 1545 1386 1572">1. Unplug oven. <li data-bbox="573 1583 1386 1610">2. Remove screw from side of oven. <li data-bbox="573 1621 1386 1677">3. Remove bulb by turning counterclockwise, being careful not to burn fingers or break bulb. <li data-bbox="573 1688 1386 1715">4. Reconnect power to oven.

Before Calling for Service

Record all inspections and repair for future reference.



WARNING

To avoid electrical shock which can cause severe personal injury or death, do not remove outer case at any time. Only an authorized servicer should remove outer case.

Symptom	Check
If oven does not operate:	<ul style="list-style-type: none">• Check fuse or circuit breaker.• Confirm oven is plugged into dedicated circuit.• Confirm oven is on grounded and polarized circuit. Contact electrician to confirm.
If oven light does not work:	<ul style="list-style-type: none">• Confirm light bulb is screwed in tightly.• Confirm light bulb has not failed.
If oven does not accept entries when pad is pressed:	<ul style="list-style-type: none">• Open and close oven door. Press pad again.
If oven malfunctions:	<ul style="list-style-type: none">• Unplug oven, wait for 1 minute, and plug in oven.
If oven operates intermittently:	<ul style="list-style-type: none">• Check air intake and discharge area for obstructions.
Oven operates, but does not heat food:	<ul style="list-style-type: none">• Place one cup cool water in oven. Heat for one minute. If water temperature does not rise, oven is operating incorrectly and a service should be called.